



## WORKSHOP EQUIPMENT



**858**

"Express" roller cabinets .....	858
Mobile lifting equipment .....	860
Hydraulic presses .....	867
Inspection creepers .....	870
Power levers .....	871

## ELECTRIC AND HYBRID VEHICLES



**872**

Consigning kits .....	872
Safe .....	873
Sign posts and chains .....	874
Consigning roller cabinet .....	875

## OIL CHANGE-FILTRATION



**876**

Drain plug wrenches .....	876
Magnetic drain plug bits and sockets .....	877
Gearbox and differential drain plug bits .....	879
Oil-filter wrenches .....	881
Cap wrenches and sockets .....	885

## SPARK PLUGS



**886**

Petrol spark plug wrenches .....	887
Petrol and glow plug wrenches .....	890
Diesel glow plug wrenches .....	890

## AUTO ELECTRICS



**893**

Testers and multimeters .....	893
Battery charger .....	895
Battery tools .....	897
Fuses and connectors .....	899
Car radio tools .....	900

## POWER PLANT



**901**

Pressure testing .....	901
Common rail diesel injection .....	907
Fuel injection .....	910
Collars - hoses - gaskets .....	911
Cooling circuit .....	915
Cylinder head - valves .....	916
Angular range .....	921
Pistons - piston rings .....	923
Exhaust .....	924

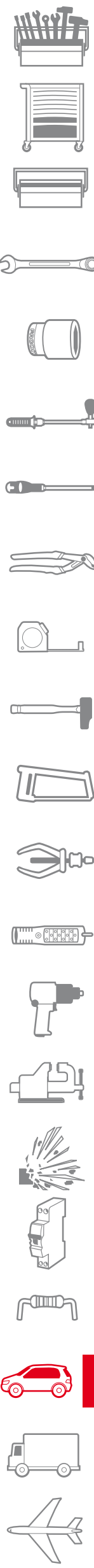

## TIMING - PULLEYS - BELTS



**927**

- Diesel engine timing kit ..... 928
- Pulleys - sprockets - belts ..... 932

## TRANSMISSION



**936**

- Gearbox and clutch ..... 936

## BRAKES



**937**

- Check ..... 937
- Diagnostics and bleeding ..... 939
- Disc brakes ..... 941
- Drum brakes ..... 942
- Brake lines ..... 944

## SUSPENSION



**946**

- Spring compressors ..... 946
- Workstation ..... 950
- Strut removal ..... 951
- Tools for shock absorbers ..... 952

## WHEEL - HUB - TRANSMISSION



**953**

- Wheel removal and inspection ..... 953

## BODYWORK



**958**

- Withstands ..... 958
- Stripping tools ..... 962
- Power tools ..... 963
- Cutting - drilling ..... 964
- Air tools ..... 968
- Forming ..... 971
- Paint preparation ..... 981
- Windshields ..... 985
- Hydraulic equipment ..... 987



"Express" roller cabinets

# "EXPRESS" ROLLER CABINET

## DESIGNED FOR FAST SERVICING

### SAVES TIME AND MONEY DURING FAST FIT & MAINTENANCE SERVICES

#### Save time by simplifying actions and movements

- Energised tooling available at all times.
- Easy moving and rotation.

#### Reduces fatigue and MSD (musculoskeletal disorders)

- Limits carrying, when removing the wheel, just swivel it to lay it on the appropriate holder at the same height.
- With its 5<sup>th</sup> wheel at the center, turn the roller cabinet with a finger for easy access to the drawers and limited wheel carrying when refitting.

#### Securing the tooling

- Tools stored in foam modules, in the roller cabinet drawers.

#### Available in 2 versions

- DLS.T1: 3 drawers.
- DLS.T2: 5 drawers.

- 1 2 wheel holders at height to limit carrying and effort.
- 2 Paper roll and work order holder.
- 3 Bottle container or large-size bin.
- 4 5<sup>th</sup> wheel for one-finger swivelling.
- 5 Power tools available instantly.



■ **DLS.T1** "Express" 3-drawer roller cabinet



- 3-drawers version:
  - 2 drawers height: 60 mm.
  - 1 drawer height: 120 mm.
- Air supply built into the roller cabinet.
- 2 hoses for air tooling.
- Cleaning spray storage tray.
- Cleanliness service: paper roll holder.
- Repair order holder.
- Ribbed aluminium tray for filling cans (5L cans).
- Supplied with 1 multifunction hook for impact wrench or inflater.
- Drawers can accommodate 2 XL modules.
- Dimensions (L. x D. x H.): 666 x 630 x 970 mm (box).
- Arm size:
  - Folded: 190 mm.
  - Open: 440 mm.
- Weight: 83 kg.

■ **DLS.T2** "Express" 5-drawer roller cabinet



- 5-drawer version:
  - 3 drawers height: 60 mm.
  - 1 drawer height: 120 mm.
  - 1 Drawer, bin dim.: 295 mm.
- Air supply built into the roller cabinet.
- 2 hoses for air tooling.
- Cleaning spray storage tray.
- Cleanliness service: paper roll holder.
- Repair order holder.
- Ribbed aluminium tray for filling cans (5L cans).
- Supplied with 1 multifunction hook for impact wrench or inflater.
- Drawers can accommodate 2 XL modules.
- Dimensions (L. x D. x H.): 666 x 630 x 970 mm (box).
- Arm size:
  - Folded: 190 mm.
  - Open: 440 mm.
- Weight: 85 kg.

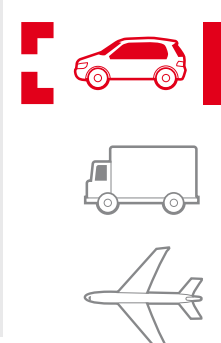
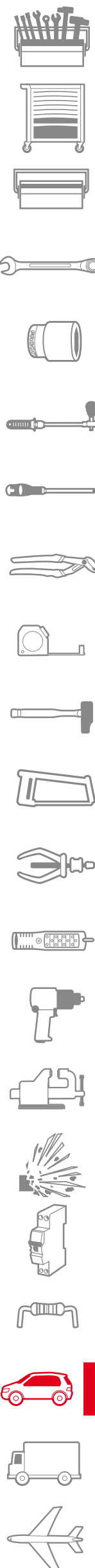



# LIFTING EQUIPMENT RANGE

## FOR FACOM, YOUR SAFETY IS PARAMOUNT

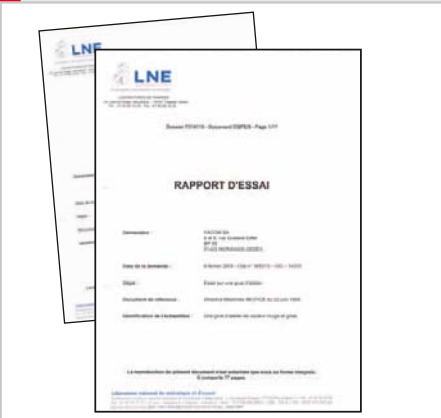

Conformity with the European directive on machinery and standards checked by an independent laboratory.



- Detailed manual.
- Exploded views.
- Spare parts list.
- Maintenance log.

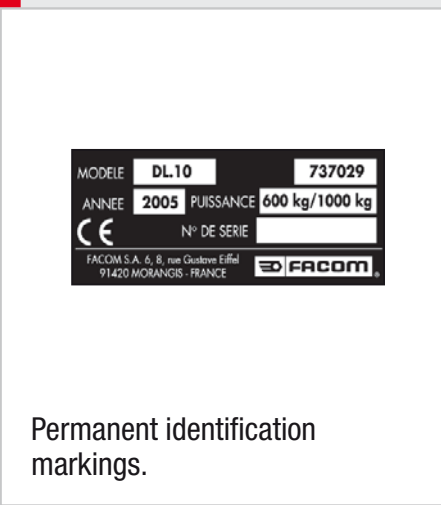

Permanent identification markings.



Comprehensive safety instructions.

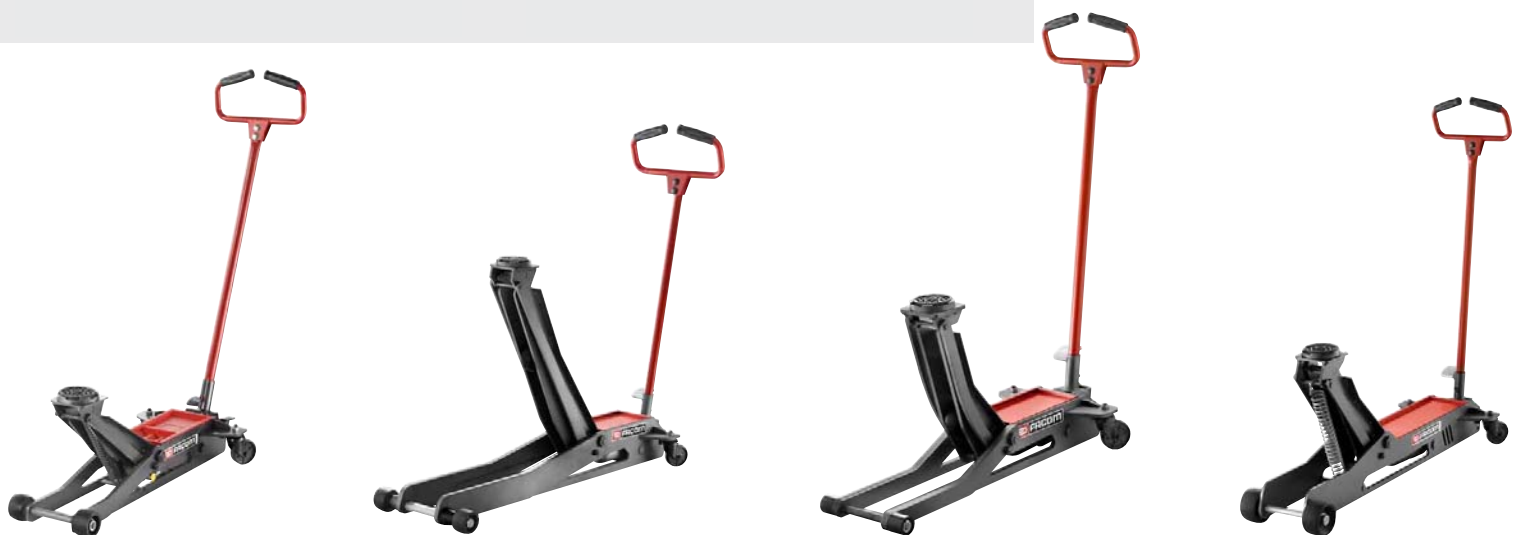

Heavy-duty trolley jacks

HEAVY-DUTY TROLLEY JACKS

CHARACTERISTICS COMMON TO HYDRAULIC JACKS OF THE "HEAVY-DUTY" RANGE

- Fast approach pedal.
- "Dead man" device.
- Load descent speed regulation.
- Comes with rubber bearing protection plate.
- Compliant with CE directive on machinery 2006 and EN 1494.

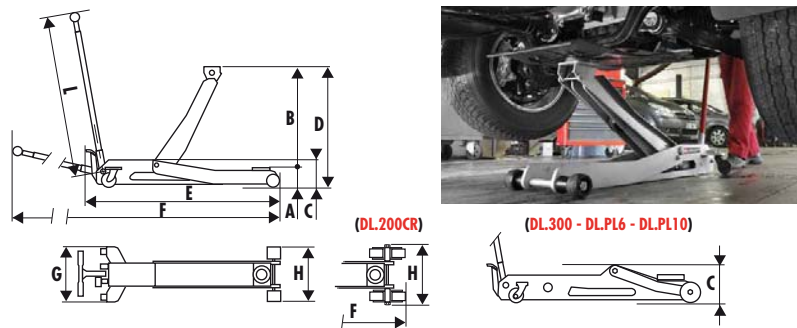

➤	F (t)	A mm	B mm	C mm	D mm	E mm	F mm	G mm	H mm	L mm	Weight	Oil
<b>DL.150HL</b>	1,5	110	665	165	775	1250	2180	360	360	1030	60.5 kg	410 cm <sup>3</sup>
<b>DL.200/DL.200SL</b>	2	75	390	135	465	880	1810	360	260	1030	32 kg	215 cm <sup>3</sup>
<b>DL.200CR</b>	2	75	390	135	465	940	1870	360	330	1030	33 kg	250 cm <sup>3</sup>
<b>DL.200LP</b>	2	65	455	135	520	920	1850	360	260	1030	44.5 kg	270 cm <sup>3</sup>
<b>DL.300</b>	3	140	385	185	525	1150	2080	360	260	1030	46 kg	410 cm <sup>3</sup>
<b>DL.PL6</b>	6	170	410	220	580	1310	2215	414	336	950	81 kg	775 cm <sup>3</sup>
<b>DL.PL10</b>	10	170	435	270	605	1600	2530	414	386	950	123 kg	1,150 cm <sup>3</sup>

DL.200LP 2T gearbox & engine support trolley jack



NF EN 1494, EN 1494, DIN EN 1494

- Ideal for low ground clearance sports vehicles.
  - Load capacity: 2 t.
  - Maximum lifting height: 520 mm.
  - Minimum height under body: 48 or 65 mm.
  - Fast approach pedal.
  - "Dead man" device.
  - Load descent rate regulation.
  - Supplied with rubber plate protection.
  - Dimension (L. x W.): 920 x 260 mm.
- Weight: 43 kg.

DL.200SL 2T "safety" trolley jack



NF EN 1494, EN 1494, DIN EN 1494

- Load capacity: 2 t.
  - Maximum lifting height: 465 mm.
  - Minimum height under body: 75 mm.
  - Maximum chassis height: 135 mm.
  - Fast approach pedal.
  - "Dead man" device.
  - Load descent rate regulation.
  - Additional safety device: mechanical locking at 320 mm (with a 2nd release pedal).
  - Supplied with rubber plate protection.
  - Dimensions (L. x W.): 880 x 260 mm.
- Weight: 32 kg.

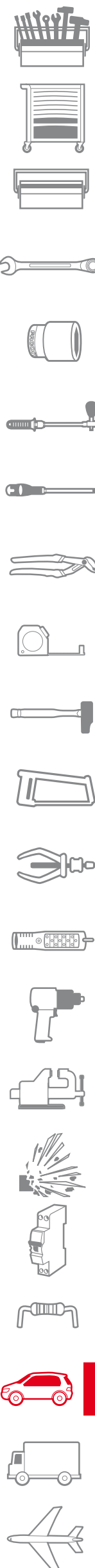



## DL.200CR 2T - 6 wheel "safety" trolley jack



### NF EN 1494, EN 1494, DIN EN 1494

- Boggie wheels: for easy moving on rough floor, access to paint booths and better stability.
  - Load capacity: 2 t.
  - Maximum lifting height: 465 mm.
  - Minimum height under body: 75 mm.
  - Maximum chassis height: 135 mm.
  - Fast approach pedal.
  - "Dead man" device.
  - Load descent rate regulation.
  - Additional safety device: mechanical locking at 320 mm (with a 2nd release pedal).
  - Supplied with rubber plate protection.
  - Dimensions (L. x W.): 880 x 260 mm.
- Weight: 33 kg.

## DL.150HL 1.5T high lift "4x4" trolley jack

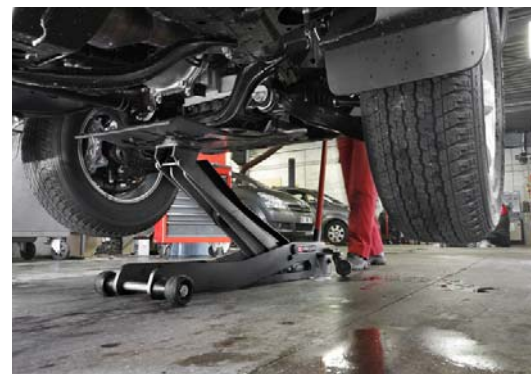

### NF EN 1494, EN 1494, DIN EN 1494

- Load capacity: 1.5 t.
  - Maximum lifting height: 775 mm.
  - Minimum height under body: 110 mm.
  - "Dead man" device.
  - Fast approach pedal.
  - Load descent rate regulation.
  - Supplied with rubber plate protection.
  - Dimensions (L. x W.): 1250 x 360 mm.
- Weight: 60.500 kg.

## DL.300 3T "L.U.V" trolley jack



### NF EN 1494, EN 1494, DIN EN 1494

- Load capacity: 3 t.
  - Maximum lifting height: 525 mm.
  - Minimum height under body: 140 mm.
  - "Dead man" device.
  - Load descent rate regulation.
- Weight: 50 kg.

HEAVY-DUTY TROLLEY JACKS

SAFETY FIRST

- In daily workshop operations, lifting a vehicle is a normal operation which, unfortunately, causes many accidents every year.
- A jack can be used only to lift or lower the vehicle, axle stands are always required to work on the vehicle.
- The new DL.200SL and DL.200CR jacks include a mechanical system locking them at 320 mm: always check that the jack is locked in the safety position before working under the vehicle.

**Reminder:** always work on flat ground and prevent any vehicle movement, using blocks if necessary.



Floor jacks "maintenance" range

DL.32 3.2T multi-purpose car and LCV's floor jack



NF EN 1494, EN 1494, DIN EN 1494

- Maximum lift 504 mm.
  - Min. under-body clearance: 145 mm.
  - Force 3.2 t.
  - Quick-lift device brings jack: into contact in a single movement.
  - Automatic air release device for constant cylinder efficiency.
  - Removable polyurethane cover on the bearing head.
  - Silent-running polyurethane-tyred wheels
  - Overload valve, CE
  - Dimensions (L. x D. x H.): 690 x 337 x 163 mm.
- Weight: 38 kg.

DL.19 Lightweight servicing trolley jack 2T



NF EN 1494, EN 1494, DIN EN 1494

- Bi-material aluminium/steel jack.
  - Force 2 t.
  - Rear carry handle.
  - Minimum jacking clearance: 100 mm.
  - Wide polyurethane cover on the bearing head.
  - Quick-lift device brings jack: into contact in a single movement.
  - Universal joint mechanism for accurate control.
  - Automatic air release device for constant cylinder efficiency.
  - Silent-running polyurethane-tyred wheels.
  - Overload valve, CE.
  - Dimensions (L. x D. x H.) 705 x 310 x 160 mm.
- Weight: 25 kg.

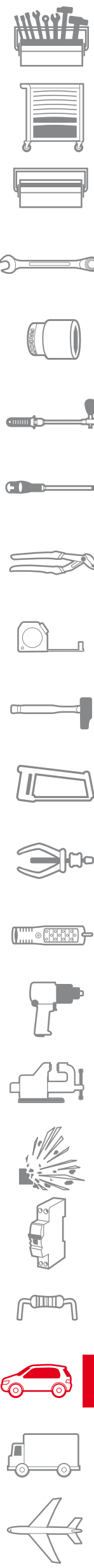



## Axle stands

### DL.3 Pair of 2.2 axle stands



- Load capacity: 2.2 t.
  - Axle stands with locking pins.
  - 6 height settings from 295 to 492 mm.
  - Pin chained to the stand.
  - Polyurethane contact surface protection.
  - CE.
  - Tested by the French national testing laboratory (LNE).
  - Folded dimensions (L. x W. x H.): 295 x 210 x 210 mm.
- Weight: 5.500 kg (per pair).

## Workshop cranes

### WORKSHOP CRANES

#### Exclusive performance:

- Easy jib length adjustment without tool nor safety pin.
- Load lowering with one millimeter accuracy with the high-precision control.
- Rotating jack at 270°: controls jib rising and lowering by the back or side of the crane.

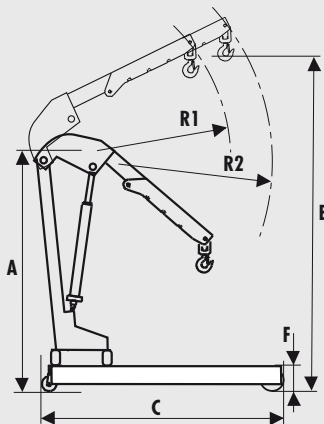

DL	A mm	B mm	C mm	D mm	E mm	F mm	G mm	R1 mm	R2 mm	Weight
DL.5	1400	2080	1500	820	450	80	465	1050	1250	97 kg
DL.10EU	1670	2440	1800	820	–	80	–	1260	1550	130 kg
DL.20EU	1690	2470	1870	820	–	200	–	1275	1570	180 kg

### DL.5 500-kg workshop crane



- Folding crane.
  - Tool-free jib extension.
  - Rotating controller: 270°.
  - Easy use, instant adjustment.
  - Capacity: 500 kg.
  - Effective load with boom deployed: 325 kg.
  - Floor dimensions: 1500 x 820 mm.
  - CE.
- Weight: 97 kg.

### DL.10EU 1T workshop crane



- Crane can be disassembled for European pallets.
  - Tool-free jib extension.
  - Rotating controller: 270°.
  - Easy use, instant adjustment.
  - Capacity: 1,000 kg.
  - Effective load with boom deployed: 700 kg.
  - Floor dimensions: 1800 x 820 mm.
  - CE.
- Weight: 130 kg.

### DL.10F Drum lifter



- To handle metal drums with a crane.
- Max. load: 300 kg.

### DL.101 Load balancer



- Allows to balance the load under the hoist according to the shape of the part or engine to lift.
- Easy adjustment by crank.
- Max. load: 600 kg.
- Center distance: 330 mm.
- Supplied with 4 fastening chains.

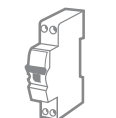



## Load balancers

### MOBILE LIFTING

#### Pit jacks

- Quick-lift device by pedal.
- "Dead man" device.
- Overload valve.
- Polyurethane wheels.
- Reversible bearing head.
- Can be fitted with foam block DL.20SUP (option).
- CE.

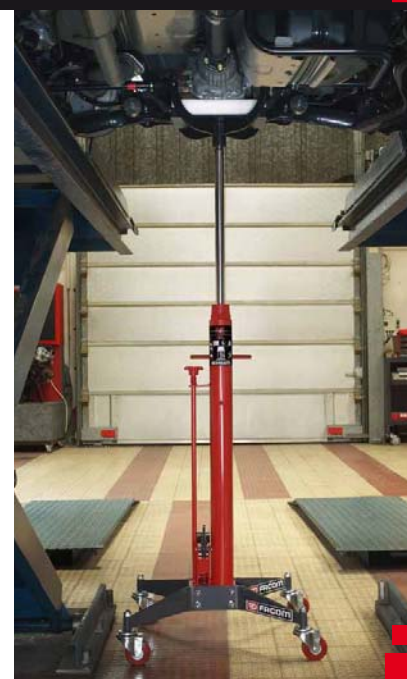

#### Pit jacks



- Max. load: 600 kg.
- "Dead man" safety lowering device.
- Safety overload valve.
- Polyurethane wheels.
- Reversible basket.
- Can support DL.20SUP (Option).
- CE.

	Dimension [mm]	$\Delta$ [kg]
<b>DL.30</b>		31
<b>DL.60</b>		39

#### DL.1200 2-stage telescopic pit jack



- For 4WD, LUV and HV below 6 t.
  - Max. load: 1200 kg.
  - Adjustable height:
    - Minimum: 900 mm.
    - Maximum: 1.900 mm.
  - Adjustable arms.
  - Load holding chains.
  - Foot control.
  - "Dead man" device.
  - Floor diameter: 650 mm.
  - Can be fitted with two optional high density foam pads (Ref DL.20SUP).
  - Supplied with swivel head.
- Weight: 35.500 kg.

#### DL.20SUP Lifting plate



- This plate supports a block of high density foam that spreads the load over a large surface area and avoids damage to aluminium crank cases and under-bodies.
  - For use on DL.200LP - DL.30 - DL.60 - DL.1200.
  - Dimensions (L. x W. x H.): 300 x 150 x 60 mm.
- Weight: 4 kg.

Hydraulic presses

WORKBENCH - SHOP PRESSES

- Supplied assembled with pair of Vees.
- Piston with automatic return spring.
- CE.

Shop presses

- Table raised by a single operator using the integral winch.
- Integral pusher support (set of pushers not supplied).
- Lateral moving jack.
- Openings in base for moving with a pallet jack, ground anchor device.

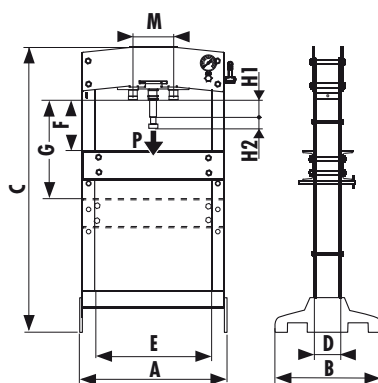

Model	P (t)	A mm	B mm	C mm	D mm	E mm	F mm	G mm	H1 mm	H2 mm	M	Weight	Oil
W.415HA	15	600	450	1050	120	500	150	450	95	75	–	74 kg	500 cm <sup>3</sup>
W.430HA	30	880	650	1830	145	710	150	700	120	75	250	195 kg	900 cm <sup>3</sup>
W.450HPA	50	880	650	1910	145	710	155	720	120	75	250	229 kg	900 cm <sup>3</sup>

W.415HA 15T hydraulic bench press



- Integral jack and pump.
- Eye-level pressure gauge.
- Piston with automatic return spring.
- Piston travel: 95 mm.
- Screw extension: 75 mm.
- Supplied assembled with a pair of Vees.
- CE.
- Dimensions (L. x D. x H): 600 x 450 x 1050 mm.
- Weight: 74 kg.

W.430HA 30T hydraulic workshop press



- Table raised by a single operator using the integral winch.
- Manual two-speed hydraulic jack, mobile laterally.
- Piston with automatic return spring.
- Piston travel: 150 mm.
- Screw extension: 75 mm.
- Floor anchoring possible.
- Integral pusher support (set of pushers not supplied).
- Supplied assembled with pair of Vees.
- CE.
- Weight: 195 kg.

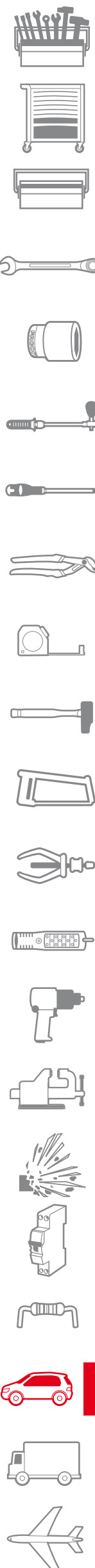



### ■ W.450HPA 50T hydropneumatic workshop press



- Hydropneumatic foot control.
  - Table raised by a single operator using the integral winch.
  - Integral pusher support (set of pushers not supplied).
  - Lateral moving jack.
  - Piston travel: 150 mm.
  - Screw extension: 75 mm.
  - Piston with automatic return spring.
  - Floor anchoring possible.
  - Supplied assembled with pair of Vees.
  - CE.
- Weight: 229 kg.

W.430-6 Set of 7 press pushers



- To be used with presses Ref. W.415HA - W.430HA - W.450HPA.
- Diameters: 12 - 16 - 18 - 20 - 22 - 25 - 30 mm.
- Length: 57 - 57 - 82 - 82 - 84 - 115 - 108 mm.
- Max loads: 3 - 8 - 12 - 14 - 18 - 18 - 20 t.

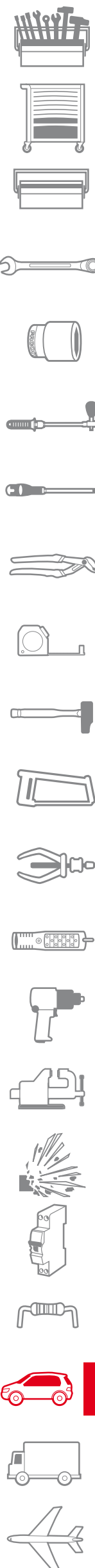

PRESS PROTECTION

WORKSHOP PRESS  
POLYCARBONATE  
PROTECTION WINDOWS

SAFE

- 2 impact-proof polycarbonate windows protect against risks of projection should a part break under the press.

FLEXIBLE

- Several height positions of the protection according to the part's size.
- Allows to position the protection flush with the part for large parts.
- Workshop 30 and 50T presses
- Available as special reference: ask your local dealer.

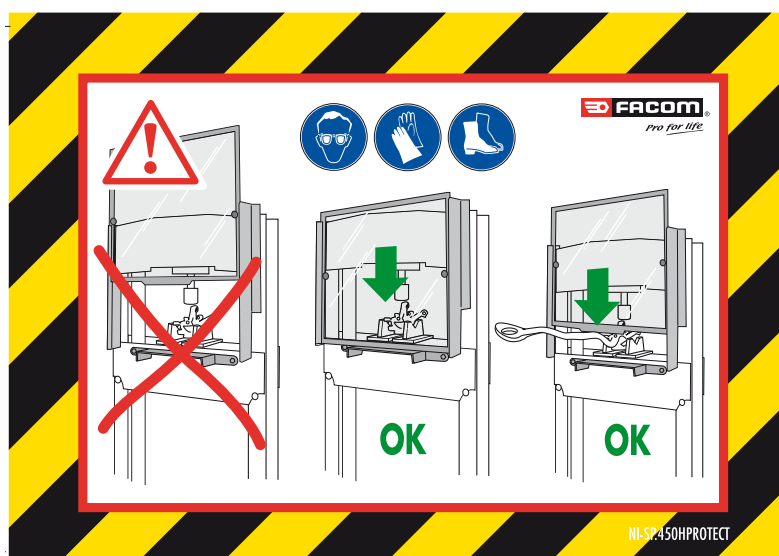



## Inspection creepers

### ▣ DTS.1B Inspection creeper



- High density foam padded vinyl headrest resistant to automotive fluid.
  - Frame made of ovoid-shape tube: no protruding angle to improve comfort and better wheel fastening.
  - Maximum height: 100 mm.
  - Max. chassis load: 150 kg.
  - 6 wheels.
  - Dimensions (L. x W.): 1010 x 630 mm.
- Weight: 8.200 kg.

### ▣ DTS.2B Heavy-duty inspection creeper



- Adjustable headrest.
  - Tool tray.
  - High density foam padded vinyl headrest resistant to automotive fluid.
  - Maximum height: 100 mm.
  - Max. chassis load: 150 kg.
  - 6 wheels.
  - Dimensions: 101 x 63 cm.
- Weight: 10 kg.

### ▣ DTS.4 Mid-height work seat



- Ideal for working on wheels, brakes and bodywork.
  - Thick heavy-duty PVC padding.
  - Stability ensured by 4 wheels diameter 75 mm.
  - Magnetic surface for fasteners and small components.
  - Overall height: 590 mm.
  - Seat height: 420 mm.
  - Dimensions (L. x W.): 463 x 430 mm.
- Weight: 10 kg.

**CR.D2** Non-magnetic wing cover with suction fasteners



- Suction fastener system: non-scratch, quick-to-install.
  - Each suction fastener can support 3 kg.
  - Suitable for use with sheet metal, aluminium and composite materials.
  - Adapts to all vehicle types.
  - Cut-out provided for wheels.
  - Easy maintenance.
  - Impact and scratch resistant.
  - High quality finish.
- Weight: 480 g.

**Pry bars**

**D.3 - Pry bars**

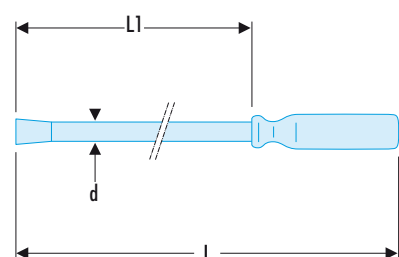

- Numerous uses: suspension, gear train, bodywork, etc.
- Sturdy blade minimising lever spring effect.

FACOM	L [mm]	L1 [mm]	ΔΔ [kg]
<b>D.3-7</b>	292	165	0,275
<b>D.3-12</b>	422	305	0,345
<b>D.3-18</b>	635	460	0,810
<b>D.3-24</b>	787	610	1,030
<b>D.3-30</b>	915	740	1,710

**D.3J3** Set of 3 pry bars



- Numerous uses: suspension, gear train, bodywork, etc.
  - Sturdy blade minimising lever spring effect.
  - Set comprising: D.3-7 - D.3-12 - D.3-18.
  - Supplied in thermoformed tray.
  - Dimensions (L. x W. x H.): 670 x 145 x 40 mm.
- Weight: 1.648 kg.

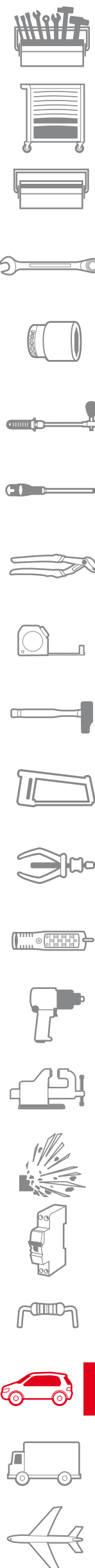



## Consigning kits

### ELECTRIC VEHICLE: FACOM EXPERTISE

#### Facom, designer-manufacturer of 1,000 Volt tools

- Leveraging their expertise in designing and making professional tools, Facom offers a range of tools and equipment adapted to maintenance of electric-hybrid vehicles.

#### Facom's automotive know-how

- In France and globally, Facom is known for their in-depth knowledge of the specific requirements of automotive maintenance. Facom's know-how in 1,000 Volt tooling is the ideal partner for your "electric-hybrid" workshop.

#### Maintenance to be reinvented

- Design of vehicles, methods and requirements of maintenance of electric-hybrid vehicles clearly changes from habits taken in "combustion" engines. It is a whole new profession!

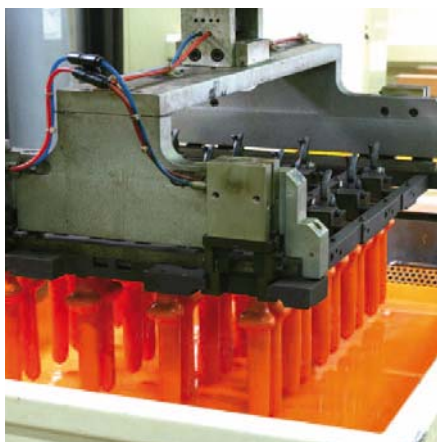

#### Safety and performance requirements.

- The particularities of electric-hybrid vehicles require specific tools and working in a 1,000 Volt environment requires observing particularly stringent safety measures.

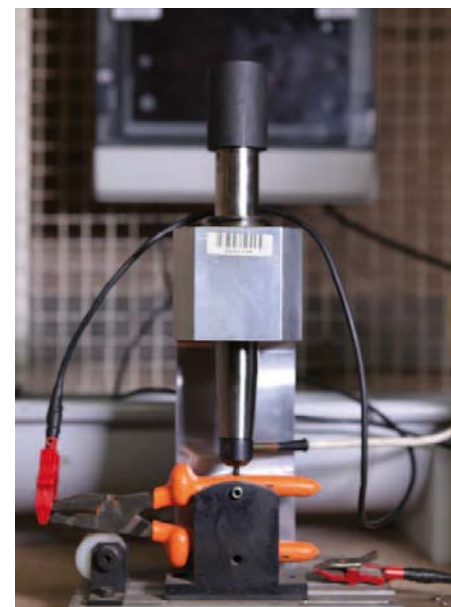

### CM.HYELPB Toolkit for electric and hybrid vehicles



- A 3/8" 1,000 Volt insulated ratchet-socket case, comprising:
  - 6 sockets: 8 - 10 - 11 - 12 - 13 - 14 mm.
  - 1 3/8" insulated T handle.
  - 2 insulated offset wrenches, dim. 10 - 12 mm.
  - 1 1,000 Volt insulated screwdriver for 5.5 x 125 flat-head screws and one 1,000 Volt Phillips® 2 x 125 head screws.
  - 1 pair of insulating gloves to EN 60903 and directive CE/89/686 category C, resistant to acid and ozone (size 10).
  - 1 pair of protection overgloves conformant to directive CE/89/686 (size 10).
  - 1 voltage absence tester conformant to NF EN 61010-600V cat 3 and IEC 61243-3 (VAT/DDT).
  - 1 neutral phase marking, continuity test, 30 mA differential circuit breaker test. Phase rotation indication.
  - Plastic case with padlock clasp (length: 650 mm).

### CM.ELPSA Toolkit for PSA Ion and C-Zero vehicles

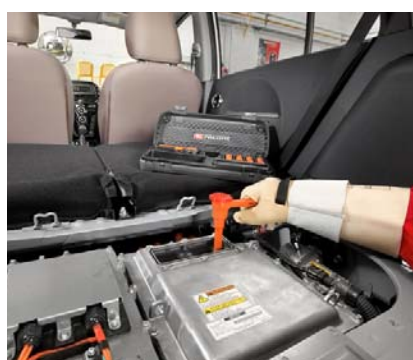

- Including:
  - 1 1,000 Volt insulated 3/8" square drive socket.
  - 4 1,000 Volt insulated sockets: 10 - 11 - 12 - 13 mm.
  - 1 1,000 Volt insulated 3/8" extension.
  - 1 1,000 Volt insulated open end wrench.
  - 1 1,000 Volt insulated half-round pliers.
  - Set suited to Peugeot iOn and Citroën C-zero vehicles.



Safe

CONTROLLED MAINTENANCE OF ELECTRIC-HYBRID VEHICLES

New technologies: precautions required

- Regulations define that a vehicle is considered as being electric when featuring an electric network of over 49 Vac and/or 120 Vdc, such as 100% electric and hybrid vehicles, and most vehicles featuring the "Stop and Start" system.
- The UTE C 18-550 standard governs the conditions of accreditation for intervention on electric-hybrid vehicles:
  - Trained and accredited operators.
  - Protection equipment.
  - 1,000 Volt insulated tools to ensure safety.

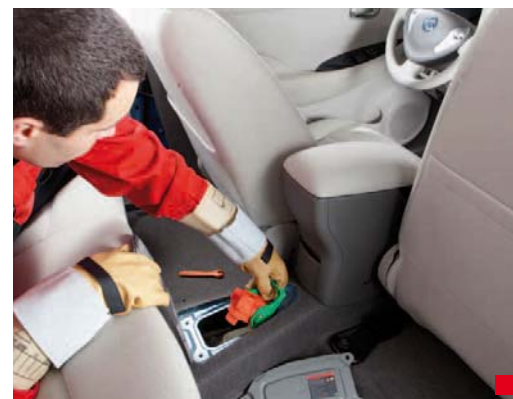

BC.VSE - Insulated gloves



NF EN 60903, EN 60903, DIN EN 60903

- Natural latex gloves, AZM classification:
    - Resistance to acid: A.
    - Resistance to ozone: Z.
    - High mechanical strength: M.
  - Length: 360 mm.
  - Supplied in anti-UV opaque bag.
- Weight: 150 g

BC	Size [mm]	E [mm]	Class	Voltage/Volt
BC.80VSE	9 (B)	0,5	00	500
BC.81VSE	10 (C)	0,5	00	500
BC.90VSE	9 (B)	1,0	0	1000
BC.91VSE	10 (C)	1,0	0	1000

BC.VSE - Safety overgloves



NF EN 60903, EN 60903, DIN EN 60903

- Silicon coated leather gloves protecting from mechanical risks.
- Used to protect latex insulated gloves.
- Physical and mechanical grade as per standard EN 388: 2, 1, 2, 1.
  - Abrasion: 2.
  - Cuts: 1.
  - Tears: 2.
  - Perforation: 1.

BC	Size [mm]	ΔΔ [g]
BC.109VSE	9 (B)	160
BC.110VSE	10 (C)	160

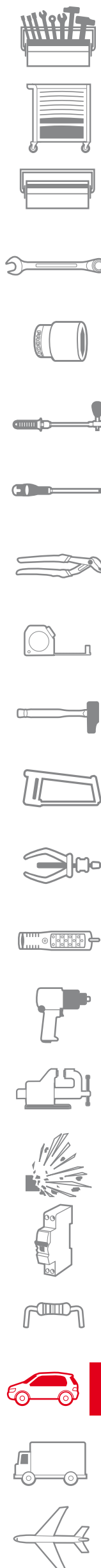



## Sign posts and chains

### YOUR SAFETY: GLOVES AND OVERGLOVES

Insulated gloves must always be checked before use.  
In case of any doubt, they should not be used.

**Caution! always wear overgloves above insulated gloves.**



#### EV.BAP Yellow and black marker posts



- Marker posts.
- Double hook for plastic chains.
- Height: 91 cm.
- Weight: 4.400 kg.

#### EV.BAP-RN Red and white marker posts



- Marker posts.
- Double hook for plastic chains.
- Height: 91 cm.
- Weight: 4.400 kg.

#### EV.CH Safety zone marker chain - black and yellow links



- Length: 25 m.
- Link diameter: 7.3 mm.

#### EV.CH-RN Safety zone marker chain - red and white links.



- Length: 25 m.
- Link diameter: 7.3 mm.

EV.PP Safety posters



- Warning post to be fitted to marker posts EV.BAP or EV.BAP-RN.
- Dimensions (L. x W.): 450 x 150 mm.

**FUTURE EVOLUTIONS: CALL YOUR LOCAL DEALER**

Facom's offer for maintenance of electric and hybrid vehicles is evolving constantly. Call your local Facom dealer for the latest developments.

Consigning roller cabinet

EV.JET-KIT Roller cabinet kit for electric vehicle work



- 6-drawer roller cabinet: JET.6M3.
- Support for 6 marker posts.
- Length of yellow and black plastic chains: 25 m.
- 6 marker posts.
- 1 warning sign.

EV.JET-SUP Support for 6 posts



- Support for 6 post markers to be fastened onto the FACOM JET + roller cabinet.

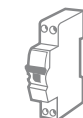



Drain plug wrenches

# D.48 OIL DRAINING

## OIL DRAIN WRENCH AND MAGNETIC BITS

### SIMPLE AND EFFECTIVE "CLEAN-HAND" OIL DRAIN

#### Hinged wrench

- Power position for easy unlocking.
- Driver position for pre-unlocking and fast removal.
- Spring-assisted joint for constant retaining load. No risk of slipping.



#### Saves time

- Magnetised drain plug bits avoid drain plugs from falling and being lost in oil collection tanks.
- The complete work support positionable on the arms of the oil collectors ensures all accessories are handy during oil change operations.

#### Handy

- Oil drain bits are removed easily with the 3/8" ejector drive.

#### Safer

- Cleaner
- Protection cup
- No contact of hands with hydrocarbons.
- Eliminates risks of burns.
- Reduces wiping paper consumption in the workshop.



- 1 Drain plug unlocking** in power position.
- 2 Drain plug removal completed** in driver position, oil drops are stopped by the protection cup.
- 3 Drain plug dripping** above the oil collector.
- 4 Bit ejector:** easy bit changing even when covered in oil, just push the protection cup.

Video demonstration on your smartphone



#### Drain kit

- Including:
- Drain plug wrench D.48.
  - 15 magnetic bits.
  - General-purpose support tray.



#### General-purpose work support

- Support for storing all drain sockets and bits with the wrench.
- Easy fastening on oil collection containers or just laid on a worktop.



#### Fittings magnetic

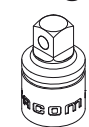

Square bits:  
8 and 10 mm.



6-point bits:  
8, 10, 12, 13, 14 and 17 mm.



6-point sockets:  
13, 14, 17, 18, 19 and 21 mm.

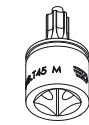

Torx®: T45

▣ **D.48-KIT** Oil change kit



- Including:
- 1 drain wrench: D.48.
- Magnetic male square bits: 8 - 10 mm.
- Magnetic female 6-point bits: 8 - 10 - 12 - 13 - 14 - 17 mm.
- Magnetic female 6-point sockets: 13 - 14 - 17 - 18 - 19 - 21 mm.
- Magnetic Torx® 45 bits.
- Support for wrench D.48 and bits.

▣ **D.48** Hinged oil drain wrench



- Oil drain wrench.
- 3/8" drive.
- Length: 280 mm.
- Weight: 440 g.
- Oil drip cup: D.48-RC.
- Magnetic oil drain support and bits: PL.IH.

**Magnetic oil drain plug bits and sockets**





▣ **MB-J15** Set of magnetic oil drain bits and sockets on rack

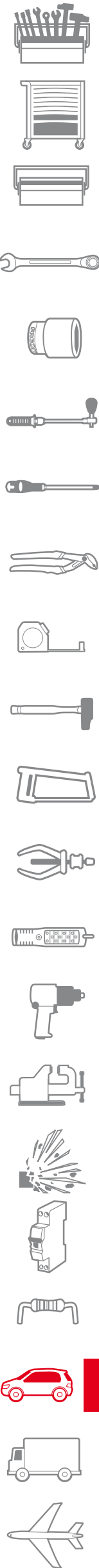

- Prevents drain plugs from falling in oil trays and collectors.
- Including:
- Magnetic drain plug bits: MB.S08 - MB.S10 - MB.H08 - MB.H10 - MB.H12 - MB.H13 - MB.H14 - MB.H17 - MB.T45.
- Magnetic drain plug sockets: MB.13 - MB.14 - MB.17 - MB.18 - MB.19 - MB.21.



MAGNETIC OIL-DRAIN PLUG APPLICATION LIST

															
	MB.13	MB.14	MB.17	MB.18	MB.19	MB.21	MB.T45	MB.S08	MB.S10	MB.MH08	MB.MH10	MB.MH12	MB.MH13	MB.MH14	MB.MH17
PSA	•	•			•	•		•		•					
Renault	•	•	•		•	•		•	•	•					
Dacia								•							
VAG	•		•	•	•						•	•	•		•
Mercedes	•	•					•	•		•					•
MCC	•														
BMW			•							•					
Opel	•	•	•		•		•	•				•		•	
Mini	•	•								•					
Jaguar	•				•			•							
Rover			•		•	•									
Austin															
Land Rover						•									
Fiat	•		•	•	•		•			•	•	•			
Alfa Roméo		•	•	•	•					•	•	•	•		
Lancia				•	•					•	•	•			
Toyota	•	•				•		•		•					
Lexus		•													
Nissan	•	•	•		•	•		•		•					
Honda	•		•	•		•									
Suzuki	•		•	•	•								•		
Mitsubishi	•		•	•	•			•							
Kia			•	•	•										
Daewoo			•	•	•										
Hyundai			•	•	•			•							
Daihatsu		•													
Mazda	•		•	•	•			•							
Subaru			•	•	•	•									•
Ford	•		•	•	•	•		•	•	•	•	•		•	
Chevrolet			•												
Jeep	•														
Chrysler	•		•		•					•					
Volvo	•		•	•	•	•		•		•					
Saab	•				•										
Lada			•									•			

3/8" 6-point magnetic oil-drain sockets



- Prevents drain plugs from falling in oil trays and collectors.
- 3/8" drive bit.
- 6-point socket.

	⌀ [mm]
MB.13	13
MB.14	14
MB.17	17
MB.18	18
MB.19	19
MB.21	21

MB.T45 3/8" Torx® magnetic oil-drain key



- Prevents drain plugs from falling in oil trays and collectors.
- 3/8" drive bit.
- Torx® 45.



3/8" magnetic oil-drain key



- Prevents drain plugs from falling in oil trays and collectors.
- 3/8" drive bit.



MB.S08

MB.S10

3/8" magnetic oil-drain male hex bits



- Prevents drain plugs from falling in oil trays and collectors.
- 3/8" drive bit.



MB.H08

MB.H10

MB.H12

MB.H13

MB.H14

MB.H17

Gearbox and differential drain plug bits

D.106-10 3/8" oil-drain female square bit 10 mm.



- 3/8" square drive bit.
- Square: 10 mm.
- Weight: 40 g.

D.109-10 3/8" drain plug bit with male triangle



- 3/8" square drive bit.
- Square: 10 mm.
- Weight: 40 g.

D.120-16 Drain plug bit with XZN pattern



- XZN pattern: diam. 16 mm.
- Drive 3/8"
- V.A.G. gearbox
- Weight: 40 g.

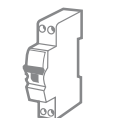

## ▣ D.13A Drain plug wrench for CITROËN, RENAULT, PEUGEOT engine



- Square bit: 8 x 10 mm.
  - Length: 230 mm.
  - Finish: chromed.
- Weight: 230 g.

## ▣ P.27B Drain plug wrench for CITROËN, PEUGEOT engine

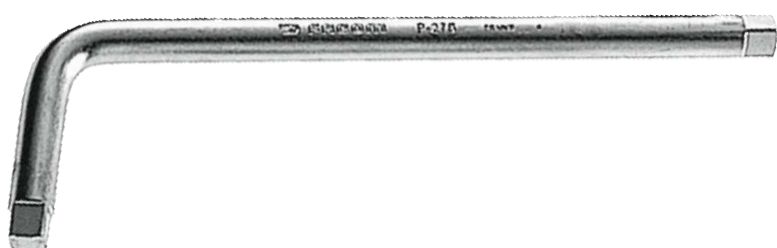

- Male square: 10 mm.
- Weight: 270 g.

## ▣ F.63C Engine, gearbox and differential drain plug wrench



- For auto makers: ALFA ROMEO, FIAT, LANCIA.
  - Male hex: 12 mm.
- Weight: 280 g.

## ▣ T.273 Gearbox and differential drain plug wrench



- For auto makers: RENAULT, VOLVO.
  - Male square: 8 mm.
  - Female square: 10 mm.
  - Length: 260 mm.
- Weight: 340 g.

Oil-filter wrenches

A SOLUTION FOR EACH TYPE OF FILTER

**Cartridge filter:**

- To remove cartridge filters, when space allows, strap wrenches are the easiest and fastest to use.
- When space is critical, use automatic or adjustable wrenches.



**Removable filters with a composite bell - 6 point drive:**

- To remove the bell, use a D.163-“size of 6-point” socket.
- With their specific design, sockets for composite oil filter bells allow to work in the most crowded environments, while preserving the composite bell from any damage.



**Removable filters with a composite bell - other drives:**

- To remove these oil filter bells, always use an adjustable wrench of the DE or DP series.
  - Their specifications and rigidity eliminate any risks of breakage of the composite bell.
  - Determine the reference of the adjustable wrench with the oil filter dimensions:
    - DE for notched filters, DP for pointed filters.
    - The first group of numbers is the filter diameter.
    - The second group of numbers is the number of points or notches.
- Example: DP.88-16 - adjustable wrench 88 mm, 16-point.



**U.46ACL Fast oil-filter wrench**

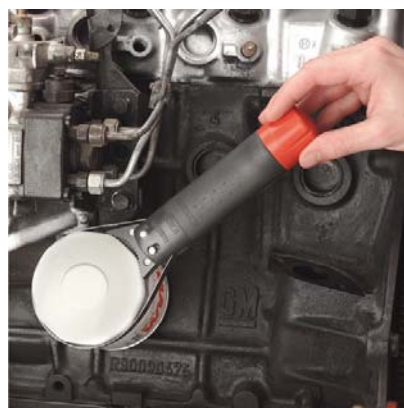

- Fast oil-filter wrench for cars.
  - Max length: 290 mm (for filters diam.: 66 --> 106 mm).
  - Ratchet effect increment: 5°.
  - Spare strap U.46ACL06 for oil filter wrench.
- Weight: 345 g.

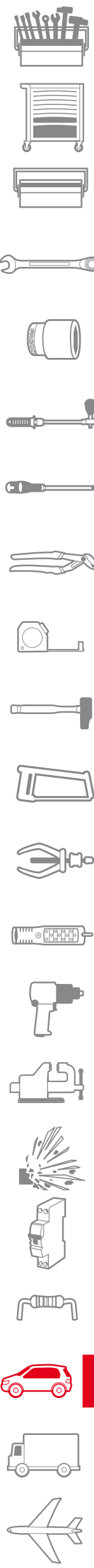



U.48

**AUTOMATIC OIL-FILTER WRENCH**

**SAVES TIME:  
AUTOMATIC, RATCHET  
EFFECT**

**No adjustment.**

- Fits diameters 66 to 105 mm.
- Strap torque control for optimum ratchet effect.
- Universal torquing force regardless of the size of the filter.
- Available for HGV for 106 to 150 mm filters.



Set



Position and release

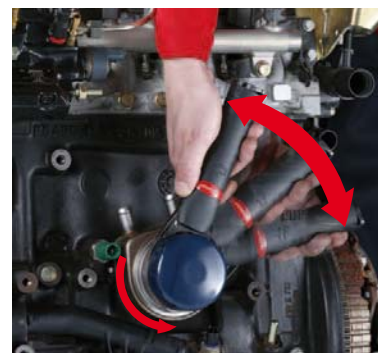

Ratchet effect ensures quick tightening and loosening



**U.48 Automatic oil-filter wrench for cars**



- For cars.
  - For filters diam.: 66 --> 105 mm.
  - Ratchet effect increment: 5°.
  - Optimised automatic tightening.
  - Spare strap U.48-2 for oil filter wrench.
- Weight: 285 g.

**U.48PL** Automatic oil-filter wrench for HGV's



- For HGV's and farming vehicles.
  - For filters diam.: 106 --> 145 mm.
  - Ratchet effect increment: 5°.
  - Optimised automatic tightening.
  - Spare strap U.48-PL2 for oil filter wrench.
- Weight: 290 g.



**U.46** Adjustable oil-filter wrench for cars

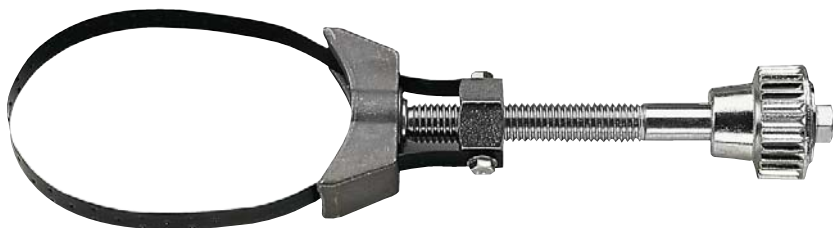

- Automatic oil filter wrench for cars.
  - Max length: 260 mm (for filters diam.: 65 --> 105 mm).
  - Spare strap U.46-2A for oil filter wrench.
- Weight: 310 g.

**U.46PL** Adjustable oil-filter wrench for HGV's

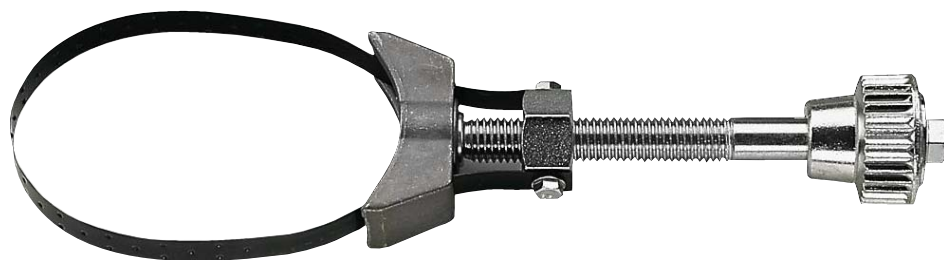

- Automatic oil filter wrench for HGV's and farming vehicles.
  - For filters diam.: 105 --> 145 mm.
  - Max length: 300 mm.
  - Spare strap U.46APL2 for oil filter wrench.
- Weight: 350 g.

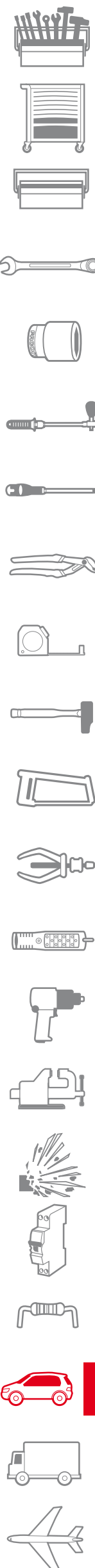

## ▣ D.149 Chain wrench



- To remove oil filters when access is not possible with an oil-filter wrench.
  - 1/2" drive bit.
  - For oil filters: 50 --> 110 mm.
- Weight: 280 g.

## ▣ D.151A Self-gripping oil-filter wrench for cars



- For cars.
  - 3/8" drive bit.
  - For oil filters: 65 --> 120 mm.
- Weight: 580 g.

## ▣ D.151PL Self-gripping oil-filter wrench for HGV's



- For HGV's and farming vehicles.
  - 1/2" drive bit.
  - For oil filters diam.: 95 --> 165 mm.
- Weight: 1.345 kg.

## ▣ D.163 Cap wrench



- For MANN and KNECHT filters.
  - Hexagonal - 3/8" - 19 mm drive.
- Weight: 110 g.



Cap wrenches and sockets

Cap wrenches with flats



- To be used when a strap wrench cannot be used.
- 3/8" square drive.

🔧	Filter [mm]	ΔΔ [g]
<b>D.139</b>	14-point Ø 65.0	135
<b>D.140</b>	14-point Ø 74.0	160
<b>D.141</b>	15-point Ø 92.0	205
<b>D.159</b>	14-point Ø 66.5	140
<b>D.160</b>	15-point Ø 74.0	160
<b>D.161</b>	15-point Ø 79.0	175
<b>D.162</b>	15-point Ø 89.0	200
<b>D.164</b>	8-point Ø 74.0	150

Notched cap wrenches



- To be used when a strap wrench cannot be used.
- 3/8" square drive.

🔧	Filter [mm]	Notches	ΔΔ [g]
<b>D.154</b>	Ø 66	6	200
<b>D.155</b>	Ø 76	12	225
<b>D.156</b>	Ø 86	18	268
<b>D.157</b>	Ø 96	18	295

D.163-J6 Set of 6 composite cap wrenches



- Including:
  - Cap wrenches: D.163-24 - D.163-27 - D.163-30 - D.163-32 - D.163-36 - D.163-38.
  - Module PL.472.
  - Plastic case BP.102.

Composite cap wrench sockets



- Smaller shape and volume for better accessibility.
- 6-point profile for removal without damaging composite oil filter plugs.
- 3/8" drive.

🔧	d [mm]
<b>D.163-24</b>	24
<b>D.163-27</b>	27
<b>D.163-30</b>	30
<b>D.163-32</b>	32
<b>D.163-36</b>	36
<b>D.163-38</b>	38

Composite cap wrenches with flats



- Special cap wrench to fit and remove composite notched oil filter plugs without damaging them.

🔧	Filter [mm]
<b>DE.66-18</b>	Ø 66
<b>DE.96-18</b>	Ø 99
<b>DP.75-16</b>	16-point Ø 75
<b>DP.76-14</b>	14-point Ø 76
<b>DP.88-16</b>	16-point Ø 88
<b>DP.102-14</b>	14-point Ø 102

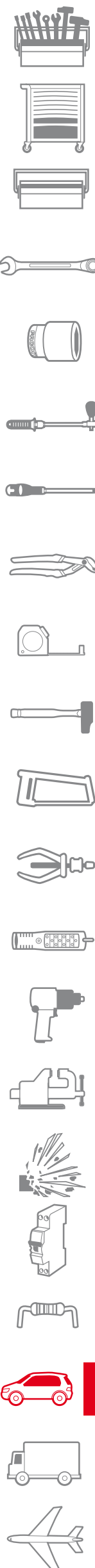

# SPARK PLUG WRENCH SELECTION GUIDE AND RECOMMENDED TORQUES

## FACOM SPARK PLUGS COMPLY WITH THE ISO 11168 STANDARD

### This standard guarantees

- Sufficient play to enable the plug to engage in the cylinder head without risk of cross-threading.
- The spark plug's angle of freedom must also be limited to avoid damaging the insulation.

### A range for each application.

- 3/8" socket: the most compact sockets. Most comprehensive range, 14 mm multi-point spark plug sockets are available only in this range.
- 1/2" sockets: most widely-used range, but not suited to modern multivalve engines.
- Hinged wrenches: ideal for congested spaces. Use for high productivity. To be used when engine layout prevents the use of a torque wrench.
- Box wrenches: compact and lightweight, particularly suited to tool bags.

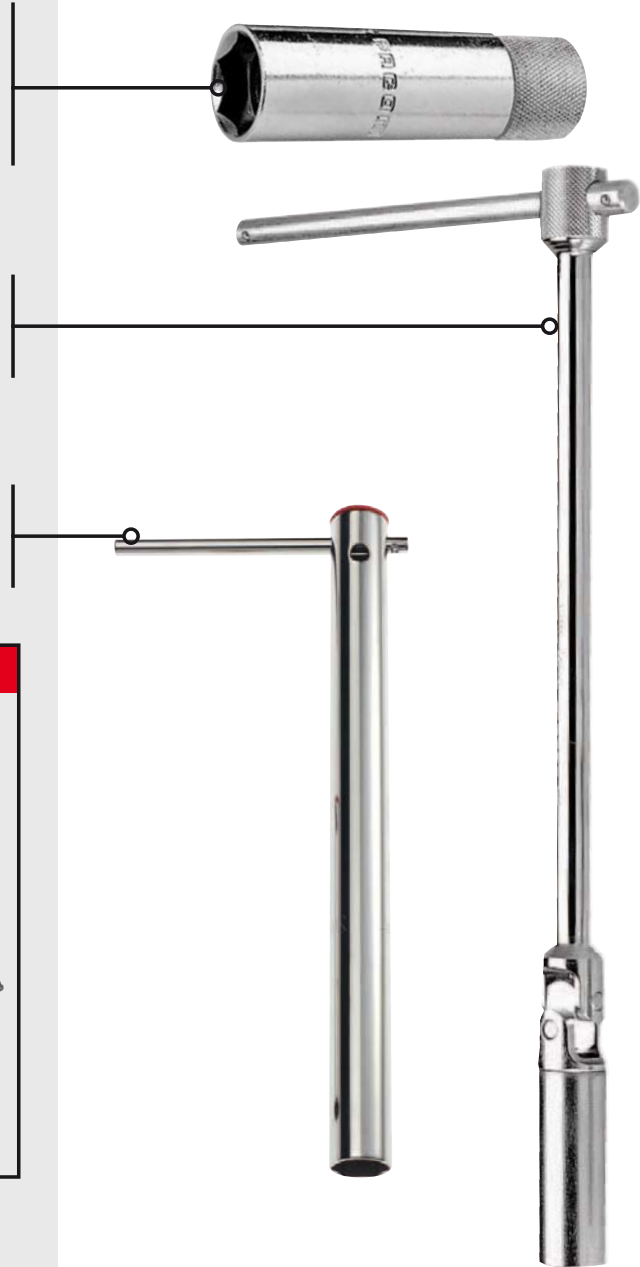

### TORQUE TIGHTENING OF SPARK PLUGS

- Cylinder heads are made of aluminium alloy. The cylinder heads of modern engines are subjected to increasingly high stresses. Reduction of thread diameters. Therefore, spark plugs must always be torqued. The J.208-50 torque wrench is ideal for tightening spark plugs.

	Flat seating (with seals)			Conical seating	
Thread diameter (mm)	18	14	12	18	14
Cast-iron cylinder head (Nm)	35-45	25-35	15-25	20-30	15-25
Aluminium cylinder head (Nm)	35-40	25-30	15-20	20-30	10-20

- Values indicated for information only, always refer to manufacturer values.





## Petrol spark plug wrenches

### 3/8" square drive sockets

#### 3/8" square drive sockets for 14 mm bi-hexagonal spark plugs

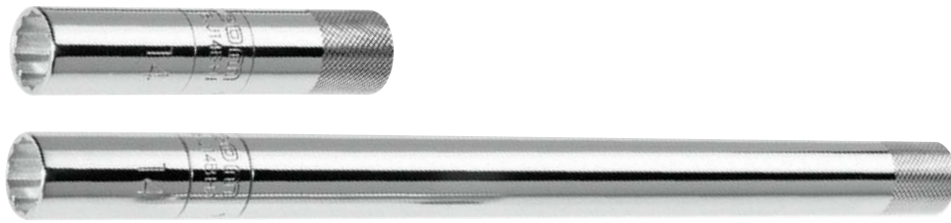

- Slim profile sockets (for spark plugs): 14 mm.
- Fitted with spark plug retainer.
- For new Renault and Peugeot engines.
- 3/8" drive.

➤	l [mm]	ΔΔ [g]
<b>B.J14BH1</b>	90	90
<b>B.J14BH2</b>	250	245

#### 3/8" square drive sockets for 16, 18 and 21 mm spark plugs



#### NF ISO 11168, ISO 11168

- Sockets with spark plug retainer.

➤	d [mm]	l [mm]	ΔΔ [g]
<b>B.J16A1</b>	16,0	90	130
<b>B.J16A2</b>	16,0	250	350
<b>B.J18A1</b>	18,0	90	190
<b>B.J21A1</b>	20,8	90	200
<b>B.J21A2</b>	20,8	250	650

### 1/2" square drive sockets

#### 1/2" square drive sockets for 16, 18 and 21 mm spark plugs



#### NF ISO 11168, ISO 11168

- Slim profile sockets (for spark plugs): 16 - 18 - 21 mm.
- Fitted with spark plug retainer.
- For new Renault and Peugeot engines.
- 3/8" drive.

➤	l [mm]	ΔΔ [g]
<b>B.S16A1</b>	90	130
<b>B.S16A2</b>	250	350
<b>B.S18A1</b>	90	190
<b>B.S21A1</b>	90	200
<b>B.S21A2</b>	250	650

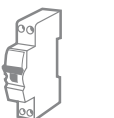
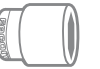
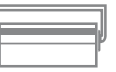

# Spark plugs

## Hinged wrenches

### ▣ B.J - 3/8" square drive hinged sockets for 16, 18, 19 and 21 mm spark plugs



- Sockets with spark plug retainer.

▣	E [mm]	l [mm]	ΔΔ [g]
<b>B.J16R1A</b>	90	385	175
<b>B.J16R2A</b>	170	465	825
<b>B.J18R1A</b>	90	385	760
<b>B.J19R1A</b>	90	385	760
<b>B.J21R1A</b>	90	385	785
<b>B.J21R2A</b>	170	465	1000

## Box wrenches for spark plugs

### ▣ Box wrenches for 16 and 21 mm spark plugs



#### NF ISO 11168, ISO 11168

- Models L and M feature spark plug retainers.
- Removable tee-bar gives working angle at 90°.
- Tee-bar storage within wrench body.

▣	d [mm]	l [mm]	ΔΔ [g]
<b>L.16AC</b>	22,0	90	160
<b>L.16AM</b>	22,0	160	235
<b>L.16AL</b>	22,0	300	395
<b>L.21C</b>	26,0	90	180
<b>L.21M</b>	26,0	160	280
<b>L.21L</b>	27,5	300	460

## Spark plug lead pliers

### ▣ DM.28 Spark plug lead pliers



- For disconnecting spark plug without harming leads.
  - No damage to connectors.
  - Dimensions (L. x W. x H.): 198 x 30 x 55 mm.
- Weight: 210 g.

Feeler gauges

804 Round tip metric thickness gauges



- Set of 19 feeler gauges (round tip): 4/100 --> 100/100 mm.
- Blade length: 90 mm.
- Weight: 60 g.

804.AM Anti-magnetic metric thickness gauges

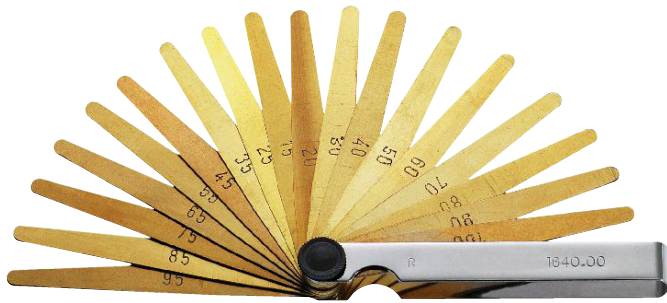

- Set of 19 feeler gauges (tapered tip): 10/100 --> 100/100 mm.
- Blade length: 100 mm.
- Brass blades.

804.P Sharp tip metric thickness gauges



- Set of 19 feeler gauges (tapered tip): 4/100 --> 100/100 mm.
- Blade length: 90 mm.

804.U Inch thickness gauges



- Set of 26 feeler gauges (tapered tip): 15/10000 --> 250/10000 inches.
- Blade length: 3"1/2 (88.9 mm).

804.L Long metric thickness gauges



- Set of 19 feeler gauges (round tip): 4/100 --> 25/100 mm.
- Blade length: 150 mm.

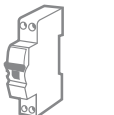
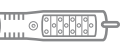
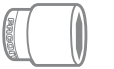
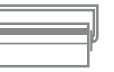



# Spark plugs

## Petrol and glow plug wrenches

### Spark plug accessories

#### ▣ **DM.20** Flexible spark-plug fitter



- Helps engaging a spark plug thread in any location.
  - For all types of spark plug.
  - Length: 316 mm.
- Weight: 50 g.

## Diesel glow plug wrenches

### Glow plug accessories

#### ▣ **D.110** Spark plug fitter



- Helps engage a spark plug thread in any location, regardless of the screw head.
  - Square drive: 6 --> 11 mm.
  - Length: 305 mm.
- Weight: 55 g.

## Diesel glow plug testing

### Spark plug files

#### ▣ **276** Contact file



- Thickness: 1 mm.
  - Length: 130 mm.
- Weight: 10 g.

## Glow plug sets

### MOD.BJ-GM Complete spark plug module



- Fitting and removal of spark plugs: 14 - 16 - 21 mm; and glow plugs: 8 - 9 - 10 - 12 mm.
- Comprising:
  - B.J14BH 1 - 2 / B.J16A 1 - 2 / B.J21A1: Spark-plug sockets.
  - B.10R8L - B.10R9L: Hinged glow plug wrenches.
  - B.10R10A - B.10R12AL: Hinged glow plug wrenches.
  - J.161: Ratchet.
  - D.110: Fitter.
  - Thermoformed module PL661A (value 2 modules).

Weight: 2.160 kg.

### MOD.BJC Spark plug service module



- Including:
  - B.J14BH1 - B.J14BH2 - B.J16A1 - B.J16A2 - B.J18A1 - B.J21A1: Spark-plug sockets.
  - DM0.20: Flexible spark-plug fitter.
  - Thermoformed module PL669A.

Weight: 1.485 kg.

### MOD.BSB Spark plug service module



- Including:
  - B.S16A1 - B.S16A2 - B.S18A1 - B.S21A1: 1/2" spark plug socket.
  - DM0.20: Flexible spark-plug fitter.
  - Thermoformed module PL668A.

Weight: 1.200 kg.

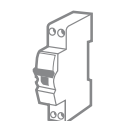

## MOD.BRA Glow plug module



- Indispensable to intervene on glow plugs in modern diesel vehicles.
- Comprising:
  - D.110: Fitter.
  - B.10R8L - B.10R9L: Hinged glow plug wrenches.
  - B.10R10A - B.10R12AL: Hinged glow plug wrenches.
  - D.133A6: Flexible screwdriver 6 mm.
  - Thermoformed module PL667.
- Weight: 910 g.

## Glow plug wrenches

### 3/8" square drive hinged wrenches for glow plugs



- Flexible spark plug fitter.
- Universal joint with friction springs for reaching socket angle required.
- Drive bit 3/8".
- Finish: polished chromed.

Ref	d [mm]	l [mm]	ΔΔ [g]
<b>B.10R8L</b>	12,0	175	120
<b>B.10R9L</b>	13,0	177	125
<b>B.10R10A</b>	14,5	161	110
<b>B.10R12B</b>	17,0	155	125
<b>B.10R12AL</b>	17,0	178	150

### 3/8" square drive sockets for glow plugs



- Fitted with spark plug retainer.
- 3/8" square drive, diam. 17 mm (Ref B.12-1) and 15 mm (Ref B.10-1).

Ref	l [mm]	ΔΔ [g]
<b>B.10-1</b>	70	70
<b>B.12-1</b>	70	80



Testers and multimeters

714 A

AUTOMOTIVE MULTIMETER

In automotive electricity, the multimeter is the indispensable complement to “diagnostic cases”. In addition to typical measurement functions: Voltmeter, Ammeter, Ohmmeter, specialised functions have been added for checking vehicles:

**Cyclic ratio:**

- Test EGR valves, petrol injectors, turbocharger wastegates.

**Measures internal resistance of batteries.**

- Detect battery faults causing voltage fluctuations. In certain vehicles, these fluctuations cause malfunction in electronic equipment.

**Large-size bargraph**

- for Lambda probe test.

Tachometer and cam angle functions to tune older vehicles with non-electronic ignition systems. The 714A is class III 600V, for work on voltages of hybrid and electric vehicles. (Within currently enforced procedures and regulations).



714A Automotive multimeter



- Measures internal resistance of batteries.
- Automatic calibre.
- Voltmeter: AC / DC 0 --> 600 V.
- Ammeter: AC / DC 0 --> 400 mA.
- Ohmmeter: 0 0 --> 40 MO.
- Continuity and LED test.
- Temperature measurement.
- Cyclic ratio: 5% --> 99% .
- Cam angle.
- Tachometer.
- Frequency meter: 1 Hz --> 400 KHz.
- Compatible with clip-on ammeter Ref 711A.P500.

AUTOMOTIVE MULTIMETER

▶ The entire multimeter program is shown in the Electricity section. See p. 788.

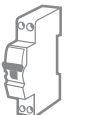
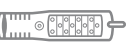
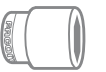

## ▣ DX.T100 Infrared thermometer



- Provides non contact infrared temperature measurement with laser guide or by contact with K thermocouple (not supplied).
- Infrared: measurement -60°C --> +500°C.
- D/S ratio (distance/surface): 11/1.
- Emissivity: adjustable.
- Mode: Min Max Differential, instant.
- Thermocouple measurement performance change according to the K probe.

## THERMOMETERS

➤ Accessories for DX.T100 are shown in electricity section. p. 789

## ▣ 700 Continuity tester



- Checks earth and lead continuity when inspecting and testing electrical circuits.
- Features two indicator lights.
- Cable length: 300 mm.
- Weight: 105 g.

## ▣ 705 Automotive voltage tester



- Filter diameter: 3 to 48 V.
- LED + or - polarity indicator.
- Complete with prodding probe, cable probe for testing insulated leads, and alligator clip.
- Dimensions (L. x W. x H.): 135 x 21 x 18 mm.
- Weight: 55 g.



## Battery charger

## BATTERY CHARGERS

## USE "NEW GENERATION" CHARGERS



BC128A

## "Anti PeakTechnology"



Standardisation of electronic equipment in vehicles requires the use of chargers which protect the battery and electronic equipment of vehicles. With a FACOM charger compliant with DIN 40839, work safely and recharge batteries without disconnecting them from the vehicle. No risk, even when reversing polarity.

## "Automatic Adaptive Charge"



The charger adapts the charging strategy permanently to the battery. Smart charging offers the following benefits:

- Safe fast charging.
- Charging secured for the battery and vehicle electronics.
- Charges batteries at 100 % capacity.
- Recharges severely discharged batteries.

## "Tester Inside"



**Don't waste time:** tester built into FACOM chargers = no more useless charging. If the battery is definitely out of service, the charger tells you when connecting to the battery. An additional test cycle is run at the end of each charge. This test reduces **after-sales return**. With **high frequency regeneration** before charging, battery plate sulphatation is reduced as the battery is in the best possible condition to be charged.

## "Regeneration"



**BOOST mode:** if the battery is highly discharged or was not used for a long period, the BOOST mode can save "borderline" batteries. **Regeneration mode:** at the start of each charge, a sulphate elimination cycle is applied to the battery elements to prepare it to receive the charge.

## SAFETY

Due to potential overheating or even fire, standard chargers are not suited to GEL, VRA and AGM batteries fitted since approximatley 2002.

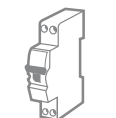
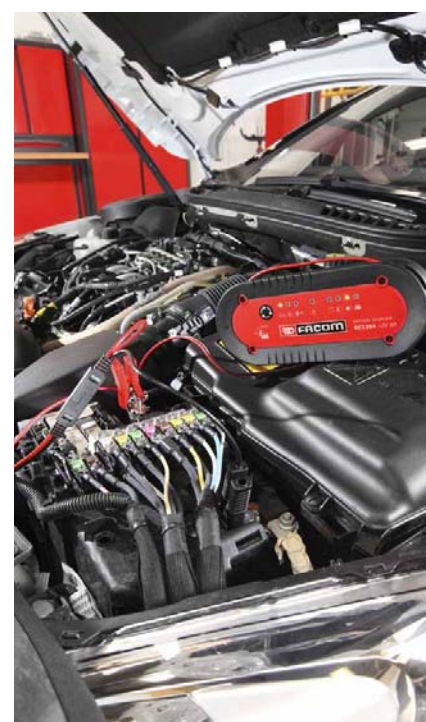



## BC124A 12 Volt battery charger for motorbikes and cars



- Automatic.
- Compatible with all "lead acid" batteries: VLRA, GEL, AGM, CALCIUM, liquid.
- "Motorbike" mode for charging small batteries.
- "Cold" mode for charging AGM and UCRA batteries.
- Can be used as maintaining charger.
- For batteries 12 V, 3 Ah to 80 Ah.
- Power supply: 220 V, 50 - 60 Hz.
- Supplied with alligator clips, a cigar lighter connector and terminal connection kit.

## BC128A 12 Volt battery charger for HGV's and utility vehicles



- Automatic.
- Compatible with all "lead acid" batteries: VLRA, GEL, AGM, CALCIUM, Liquid.
- "Power supply" mode to supply and save memory when changing a battery.
- "Cold" mode for charging AGM and UCRA batteries.
- Can be used as maintaining charger.
- "BOOST" mode to save limit batteries.
- For batteries 12 V, 20 Ah to 160 Ah.
- Power supply: 50 - 60 Hz.
- Supplied with alligator clips, a cigar lighter connector and terminal connection kit.

## BC2430A 12 - 24 volt battery charger for HGV's, CGV's, LGV's, farm equipment



- Compatible with all "lead acid" batteries: VLRA, GEL, AGM, CALCIUM, Liquid.
- "Standard" mode for humid battery.
- "Power supply" mode to supply and save memory when changing a battery.
- "Dry" mode for charging AGM, GEL and VLRA batteries.
- Can be used as maintaining charger.
- "BOOST" mode to save limit batteries.
- Automatic charge compensation according to the temperature around the battery.
- Automatic 12 - 24 V switching.
- For batteries 12 V and 24 V, 90 Ah to 600 Ah batteries.
- Power supply: 200 V, 50 - 60 Hz.
- Supplied with alligator clips.

Battery tools

**DX.11** Memory protector



- Saves configuration and stored data of vehicle accessories when battery is changed or power is temporarily interrupted.
  - Diodes for checking correct battery connection.
  - All makes.
  - Power supplied: by 12 and 24 V external battery.
- Weight: 180 g.

**12V** surge limiter

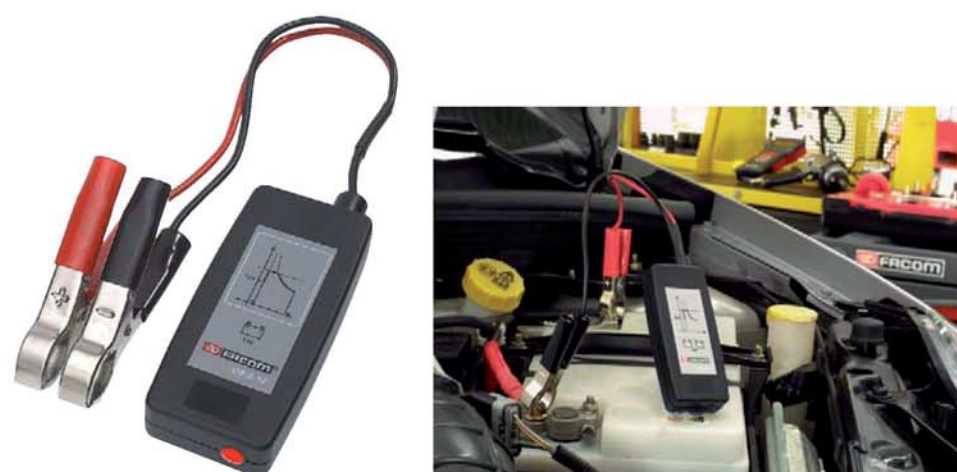

- For 12 V vehicles.
- Protects electronic components in the vehicle.
- Cable length: 300 mm.

Model	Weight [g]
DX.8-12	140

**Lug** disconnecter



- Spring loaded, self-gripping 2-leg puller.
- Example of use = battery lugs.  
Weight: 400 g.

Model	C mini - maxi [mm]	L x l x H [mm]	Screw Size [mm]	Ton [t]	P maxi [mm]	Screw Size	T [kN]	Weight [g]
U.14A	10 - 35	60 x 75 x 125	Spindle	0,5	40	U.14A04	5	340

**781** Reamer



- For cleaning contact surfaces on battery lugs and terminals.
  - Dimensions (L. x W. x H.): 26 x 92 x 130 mm.
- Weight: 230 g.

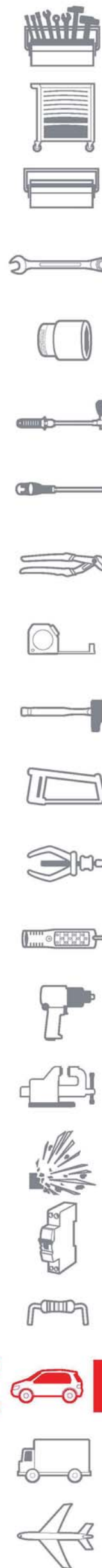



## ▣ 785 Battery filler



- Acid, oil and solvent resistant plastic.
- Length: 260 mm.
- Diameter: 70 mm.
- Weight: 85 g.

## ▣ 784B Acid hydrometer



- For checking specific gravity of battery fluid.
- Diameter: 42 --> 350 mm.
- Weight: 100 g.

## ▣ 780A Refractometer



- Two quality control measuring cycles:
  - Coolant: 0 to -50°C (graduations 5°C).
  - Battery fluid density: 1.10 to 1.40 kg / l.
- Simple screw recalibration using distilled water.
- Supplied in a case with a sampling pipette and screwdriver.
- Dimensions (L. x W. x H.): 700 x 235 x 70 mm.
- Weight: 550 g.



## Fuses and connectors

## ■ 449.Z1B Auto electricians kit



- For routine automotive electrical servicing and repair tasks: installation of accessories, car radios, trailer socket connections, fuse replacement etc.
- Contains:
  - The 12 most commonly used terminals for automotive applications (210 terminals).
  - 20x 5 dia. ring terminals for 0.5 to 1.5 mm<sup>2</sup>.
  - 20x 4 dia. spade terminals for 0.5 to 1.5 mm<sup>2</sup>.
  - 20x 5 dia. ring terminals for 1.5 to 2.5 mm<sup>2</sup>.
  - 15x 6 dia. ring terminals for 1.5 to 2.5 mm<sup>2</sup>.
  - 20x 4 dia. spade terminals for 1.5 to 2.5 mm<sup>2</sup>.
  - 20x 6.3 mm dia. quick disconnects for 1.5 to 2.5 mm<sup>2</sup>.
  - 15x 6.3 mm dia. combined quick disconnects for 1.5 to 2.5 mm<sup>2</sup>.
  - 20x 6.3 mm dia. tab terminals for 1.5 to 2.5 mm<sup>2</sup>.
  - 15x 8 dia. ring terminals for 3 to 6 mm<sup>2</sup>.
  - 15 cable couplers for 0.5 to 1.5 mm<sup>2</sup>.
  - 15 cable couplers for 1.5 to 2.5 mm<sup>2</sup>.
  - 15 cable couplers for 3 to 6 mm<sup>2</sup>.
  - 1 set of 20 fuses with extractor (5A to 30 A).
  - 1 fuse holder (for 5A to 30 A fuses).
  - 5 quick splice terminals for 0.5 to 1.5 mm<sup>2</sup>.
  - 5 quick splice terminals for 1.5 to 3.5 mm<sup>2</sup>.
  - 1 power fuse remover DX.9 (for 40A to 80A fuses) Ref DX.9: for easy replacement or removal of power fuses (e.g. for removing the fuse when working on airbags).
  - 1 pair of multi-purpose pliers 449I: for cutting wire from 0.5 to 6 mm<sup>2</sup> crimping colour-coded non-insulated terminals, cutting threaded rods from M 2.6 to M5, crimping non-insulated terminals, stripping.
- Supplied in a case.
- Dimensions (L. x W. x H.): 350 x 300 x 60 mm.
- Weight: 1.350 kg.

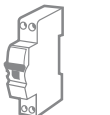
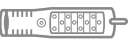

## ▣ 985894 Maintenance crimping pliers for pre-insulated terminals



### CEI60352-2, CEI 60760

- Double crimping for pre-insulated terminals in compliance with the standard, with holding on the conductor core and the insulator.
- Unlocking accessible at all times.
- Reversed crimping: terminal positioned on the fixed part for more effectiveness and precision.
- Stainless steel die with 3 cavities:
  - Red cavity: 0.5 --> 1.5 mm<sup>2</sup>.
  - Blue cavity: 1.5 --> 2.5 mm<sup>2</sup>.
  - Yellow cavity: 4 --> 6 mm<sup>2</sup>.
- Shape allowing hand setting.
- Soft touch.
- Length: 230 mm.
- Weight: 490 g.

## Car radio

### ▣ DX.25 20-piece car radio removal tool set



- 20 special tools for the main makers of car radio (Alpine, Blaupunkt, Becker, Grundig, JVC, Pioneer, VDO).
- Multi-make: BMW, Fiat, Ford, Mercedes, Opel, PSA, Renault, VAG.
- Supplied in a plastic pouch showing applications.





Pressure testing

911 AND 912

COMPRESSION GAUGES

Compression testing is a pre-requisite for good engine diagnosis. Whatever the age of the vehicle, the engine cannot run at maximum efficiency if the compression is wrongly adjusted. Electronic engine control and its self-diagnosis system will behave erratically if engine compressions are bad. More than ever, compression testing is the pre-requisite for good engine diagnosis.

Test sheet:

- Compression readings are printed on a ticket allowing simple and immediate comparison of all engine cylinders. This ticket is also used for diagnostics or return under guarantee.

Range of adaptors:

- FACOM offer a range of dummy spark plugs and dummy injectors for precise coverage of most vehicles. All these adaptors are fitted with check valves close to the engine combustion chamber and guarantee accurate measurements.



912 Petrol engine compression tester



- Test cards up to 12 cylinders.
- Integral starter-motor control.
- Working range 3 to 18 bars.
- Including:
  - 912-01-02: Hose for 911 and 912.
  - 912TN: Bare compression tester.
  - 912-12: Dummy petrol spark plugs 12 mm.
  - 912-14: Dummy petrol spark plugs 14 mm.
  - 912A.FC: Set of 100 test cards.
  - 911B.016: Starter-motor control lead.
- Dimensions (L. x W. x H.): 430 x 340 x 85 mm.
- Weight: 2 kg.

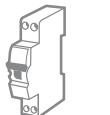
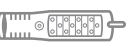
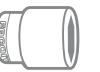



## ▣ 911 Diesel engine compression tester



- Test cards up to 12 cylinders.
- Integral starter-motor control.
- Suitable for all types of diesel engine: using dummy injectors and dummy heater plugs.
- Working range 5 to 60 bars.
- Including:
  - 912-01-02: Hose for 911 and 912.
  - 911TN: Bare diesel compression tester.
  - 911-82 - 911-102 - 911-104 - 911-105 - 911-B2 - 911-B5 - 911-B8 - 911-V4 - 911-V5 - 911-V10: Diesel dummy glow plug.
  - 911.C90: Angle adaptor.
  - 911B.FC: Pack of 100 test cards.
  - 911B.016: Starter-motor control lead.
- Dimensions (L. x W. x H.): 430 x 340 x 85 mm.
- Weight: 2 kg.

## ▣ 912A.FC Set of 100 test cards for petrol engine

- Accessory for petrol engine compression tester.

## ▣ 912-12 Flexible dummy spark plug 12 mm



- Accessory for petrol engine compression tester.
- Flexible dummy spark plug 12 mm (spark plug size 14 mm).

## ▣ 912-14 Flexible dummy spark plug 14 mm



- Accessory for petrol engine compression tester.
- Flexible dummy spark plug 14 mm (spark plug size 16 mm).

## ▣ 912-18 Flexible dummy spark plug 18 mm



- Accessory for petrol engine compression tester.
- Flexible dummy spark plug 18 mm (spark plug size 18 and 21 mm).

911-C90 Angle adaptor



- Accessory for diesel engine compression tester.

911B.FC Set of 100 test cards for diesel engine

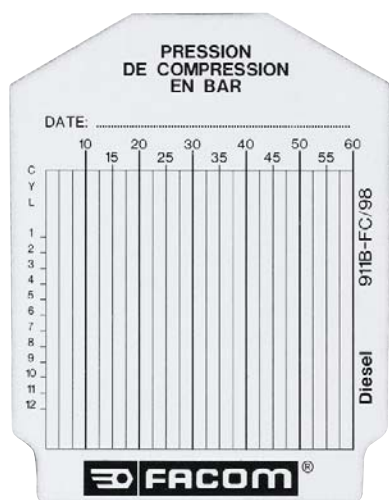

- Accessory for diesel engine compression tester.

912-01-02 Flexible fitting



- Accessory for petrol and diesel engine compression tester.
- Converts all older generations of 911 and 912 to make them compatible with the current "dummy spark plugs" and "dummy injectors" program.

911-VA Non-return valves



- Accessory for petrol and diesel engine compression tester.
- Compatible with all petrol and diesel dummy spark plugs and all dummy injectors.

911B.016 Starter cable

- Accessory for petrol and diesel engine compression tester.
- Drives the engine using the starter with ignition off.

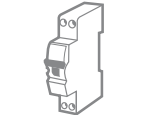
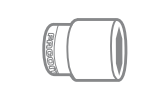



# 911

# APPLICATIONS GUIDE

## DUMMY SPARK PLUGS - DUMMY INJECTORS



																	
	PSA	RENAULT DACIA	VAG	FORD	FIAT	OPEL VAUXHALL	BMW MINI	MERCEDES	VOLVO	ROVER	NISSAN	TOYOTA	HONDA	MAZDA	MITSUBISHI	SUZUKI	CHRYSLER
1,3D			911-V4														
1,3CDTI/ JTD/ MULTIJET				911-81	911-81	911-81											
1,4D/TD			911-V4							911-V10							
1,4TDI/ TDCI/ HDI	911-82		911-102	911-182								911-82					
1,5D/TD/ DCI	911-102	911-102	911-V5			911-107		911-105			911-102					911-102	
1,6D/TD			911-V5				911-82										
1,6TDCI/ HDI/CDI	911-B8			911-B8													
1,7D/TD																	
1,7DTI/ CDTI					911-V5	911-V5 / 911-V10 911-107									911-107		
1,8D/TD			911-V5	911-V5			911-105			911-V5 / 911-V10			911-V10	911-V5			
1,9D	911-V4	911-V10			911-V5												911-V5
1,9D 64			911-V5														
1,9TD	911-V10	911-V10			911-V5 911-V10				911-V5							911-V10	
1,9TDI 75/SDI			911-V5														
1,9TDI/ DTI		911-B2	911-102	911-102													
1,9DCI/ TDCI/ CDTI/ JTD		911-B5		911-102	911-B3	911-B3											
2,0D/TD				911-106	911-V5						911-V5				911-V10		
2,0TDI 105/ DCI/DTI/ TDCI		911-106	911-102	911-B8		911-105											
2,0HDI	911-104 911-B5																911-104 911-B5
2,0HDI 136/138/ JTD/CDI	911-B8				911-104			911-105									
2,1TD	911-V10				911-V10												
2,2DT		911-V10															
2,2HDI/ CDI/DTI/ TDCI/ DCI	911-104 / 911-B8	911-105		911-106		911-105		911-105									
2,3D/TD										911-V5 / 911-V10							
2,4D/TD			911-V5		911-V5												
2,4JTD/ D5					911-91				911-82								
2,5D				911-B5 / 911-B1					911-102								
2,5TD/ TDI			911-104	911-V10							911-102						911-102
2,7TD/ HDI/CDI	911-B8							911-105				911-107					
3,0D/ CDTI						911-110	911-102										
3,5D							911-102										



High-pressure dummy glow plugs

■ Diesel dummy glow plugs 8 mm

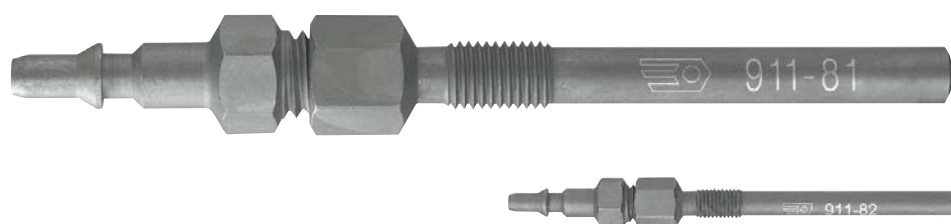

- For testing diesel engine compression.
- For use with FACOM 911 reader.
- Fitted with a non-return valve.



911-81

911-82

■ 911-91 Diesel dummy glow plugs 9 mm



- For testing diesel engine compression.
- For use with FACOM 911 reader.
- Fitted with a non-return valve.

■ Diesel dummy glow plugs 10 mm



- For testing diesel engine compression.
- For use with FACOM 911 reader.
- Fitted with a non-return valve.



911-102

911-104

911-105

911-106

911-107

911-110

High-pressure dummy injectors

■ Dummy injectors

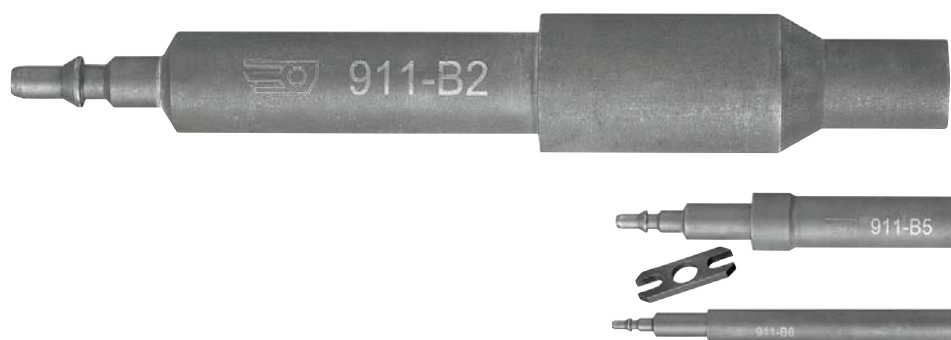

- For testing diesel engine compression.
- For use with FACOM 911 reader.
- Fitted with a non-return valve.



911-B2

911-B5

911-B8

■ Screw-on dummy injectors



- For testing diesel engine compression.
- For use with FACOM 911 reader.
- Fitted with a non-return valve.



911-V4

911-V5

911-V10

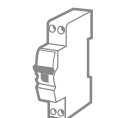

## Inlet and turbo pressure

### ▣ DA.160 Manual pressure/vacuum pump



- Manual pressure/vacuum pump.
- To test air actuators such as EGR valves, turbo wastegate valves, boost inlet pressure measurement, pressure sensors, etc.
- Allows to bleed small hydraulic circuits, prime fuel circuits.

## Oil pressure

### ▣ 914 Oil pressure tester



- Quick coupler.
  - Range: 0 to 8 bar.
  - Supplied in case complete with adaptors, seals and fittings.
  - Dimensions (L. x W. x H.): 360 x 340 x 125 mm.
- Weight: 2.13 kg.

Common rail diesel injection

COMMON RAIL

Most modern diesel engines use the common rail technology. To meet issues related with injectors, FACOM offer a comprehensive range for testing and extraction.

Pressure constraints require perfect renovation of mating surfaces before refitting a new element, and changing gaskets at every removal. FACOM offer a range of tools to renovate mating surfaces and pull gaskets blocked at the bottom of injector wells.



Common rail injector tools

DCR.IT Common rail diesel injector return flow tester



- For 2 to 8 cylinder engines.
- 4 sets of 8 brass couplings for BOSCH and Siemens injectors.
- 1 set of 8 plastic couplings for DELPHI injectors.
- Supplied with universal connecting tubes.

DCR.IP Seized common rail injector slide hammer



- For more than 80% seized injectors.
- 4 Sockets for injector heads 25 - 27 - 29 - 30 mm.
- Tool for removing the inside mechanism for BOSCH injectors.
- Dual height slide hammer.
- Supplied with adaptors for BOSCH, SIEMENS, DELPHI injectors.

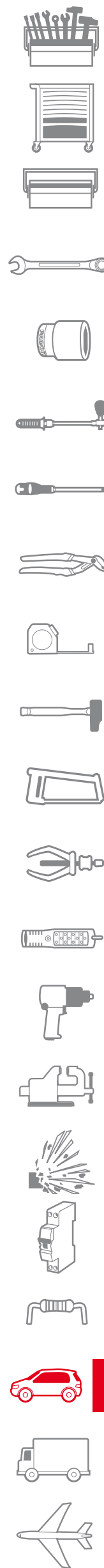



## ▣ **DCR.IPPSA** Seized common rail injector screw puller on PSA engines



- PSA 2.0L HDI 16V and 2.2L HDI 16V engines.
- Designed for use on "minivan" and utility vehicles when access does not allow to use the puller DCR.IP.

## ▣ **DCR.IPREN** Seized common rail injector screw puller on RENAULT engines



- RENAULT 2.2L DCI and 2.5L DCI engines.
- Designed for use on "minivan" and utility vehicles when access does not allow to use the puller DCR.IP.

## ▣ **DCR.IPM** PSA and RENAULT common rail injectors puller set



- Comprises the elements and covers vehicles of the DCR. IP-PSA and DCR.IP-REN pullers.

## ▣ **DCR.SR** Injector gaskets slide hammer

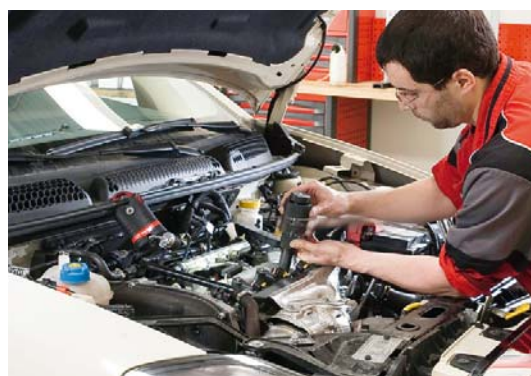

- To pull injector gaskets blocked at the bottom of the injector well.
- Avoids cylinder head removal.

**DCR.IC** Set of common rail injector well cleaning mills



- Allows restoration of the injector well and its parting surface before refitting an injector.
- Avoids compression leaks and loss.
- Supplied with 3 mills and 1 extension.

**TO PREVENT GLOW PLUGS FROM SEIZING**

**GLOW PLUG WELL CLEANING GRINDER.**

- Built-up scale between the glow element and the cylinder head results in breaking glow plugs when removing them.
- Using a glow plug well cleaning grinder reduces the risk of breakage. On “sensitive” engines, glow plugs should be changed every 80 000 KM and the glow plug wells be cleaned.



Common rail glow plug tools

**DCR.HC10** Cylinder head tool for 10 x 100 and 10 x 125 glow plugs

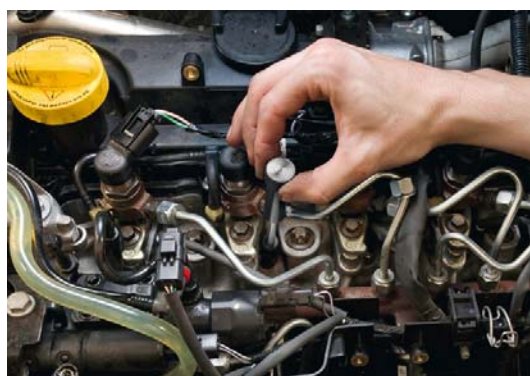

- Removes scale deposits between the cylinder head and the spark plug heating element.
- Prevents seizing and breakage of glow plugs in the cylinder heads.

**DCR.HR-REN** Toolkit for RENAULT engines: 1.5 DCI - 1.9DCI - 2.2DCI - 2.5DCI



- Allows extraction of glow plugs broken in the cylinder heads.
- For use with mounted engines.
- Drilling and tapping guide.

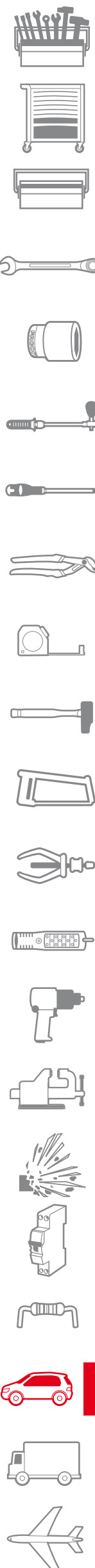

## Fuel injection

### Injectors

#### 1/2" square drive diesel injectors sockets



- 1/2" square drive 12-point long reach sockets.
- D.27A.
- D.132B.
- Available for:
  - CITROËN Saxo 1.5/Boxer TD.
  - FORD Maverick.
  - MAZDA Familia 1.7.
  - MERCEDES 250C > 94.
  - MITSUBISHI Pajero 2.
  - NISSAN Serena 2.3.
  - PEUGEOT 106/605/2.5.
  - SEAT Terra 1.7.
  - VOLKSWAGEN Polo D.

	d [mm]	l [mm]	ΔΔ [g]
<b>D.27A</b>	36	87	265
<b>D.132B</b>	29	98	160

#### D.142 1/2" square drive injector castle nut sockets



- For BOSCH injection on FIAT Croma 2.5 TD, also suitable on LV, LUV, HV diesel engine.
- Dimensions (L. x W.): 28.5 x 135 mm.
- Weight: 320 g.

#### DM.19 3/8" square drive diesel injection wrench - 17 mm

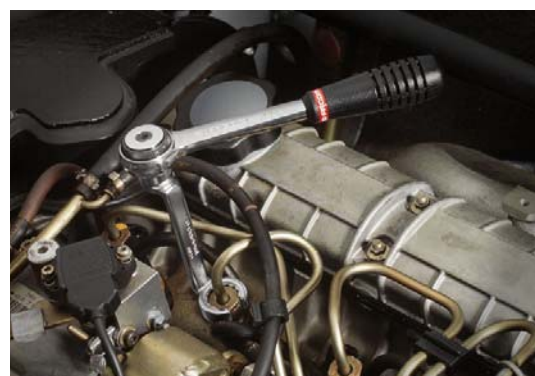

- For RENAULT Laguna and specific diesel motorisations.
- 12-point 17 mm.
- Square drive bit 3/8".
- Dimensions (L. x W.): 27 x 95 mm.
- Weight: 75 g.



■ **DM.38** 3/8" square drive diesel injection wrench - 14 mm



- For MERCEDES LV, UV and specific diesel motorisations.
- 12-point 14 mm.
- Square drive bit 3/8".
- Length: 95 mm.
- Weight: 70 g.

■ **916.600** Injector test pump



- For checking injector leak-back, injection pressure and fuel spray pattern.
- Dial gauge: 0-600 bar.
- Reservoir complete with filter.
- For use with fluid to NF ISO 4113 and vapour extractor Ref D.144.
- Dimensions (L. x W. x H.): 220 x 100 x 410 mm.
- Weight: 4.400 kg.

■ **D.144** Vapour extractor



- Collects fumes and fluid checking or adjusting injectors.
- Air inlet hose fitted with shut-off valve.
- Inlet pressure: 6 bar.
- Dimensions (L. x W. x H.): 400 x 380 x 420 mm.
- Weight: 5.200 kg.

**Clips - hoses - gaskets**

**Fuel circuit tools**

■ **DM.J** Fuel gauge wrench



- Used to dismount and refit fuel gauges bushes.
- Capacity: 88 --> 170 mm.
- Opening regulation through diaphragm.

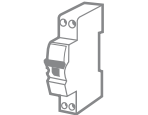
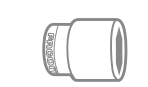

## DM.CC Automatic clamp pliers



- Pliers to open or close automatic clamps.
- Multi-direction gripping of clamps to work either vertically or horizontally (right or left).

## DM.FR2 Diesel filter fitting and removal tool



- For multi-jet 1.3 and 1.9 diesel engines in Fiat and Opel.
- Filter holder support for lock grip.
- Filter holder wrench with 3/8" square bit.
- Allows retightening at the original torque value (value indicated on the plastic cap).

## DM.F Fast fit fuel pliers

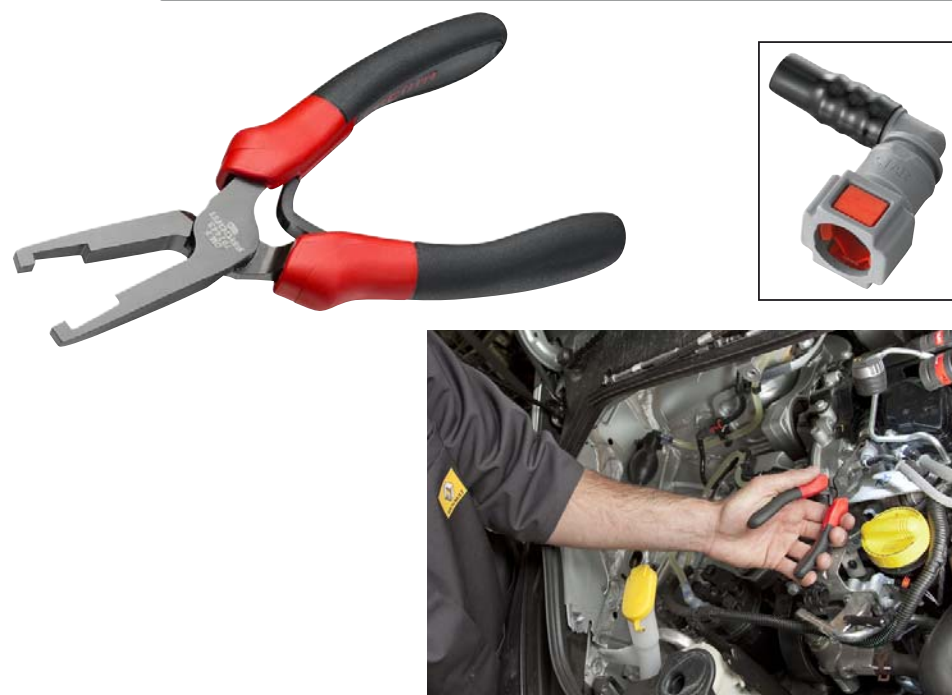

- For petrol and diesel vehicles.
- To disconnect fast fuel fittings.
- Length: 175 mm.

▣ Fuel line pliers



- To disconnect fuel line unions.
- DM.15-8. for the RENAULT make: Twingo/Laguna/Scenic.
- DM.15-10. for the RENAULT make: Laguna Diesel/Espace all types/Mégane.
- Dimensions (L. x W. x H.): 115 x 65 x 20 mm.

DM	d [mm]	l [mm]	ΔΔ [g]
DM.15-8	8	110	70
DM.15-10	10	115	67

DM.MUB - SPRING CLAMP PLIERS

FOR AN EASIER REACH

**Time-saving**

- No need to remove components obstructing the hose clamp.
- Compact and lightweight for confined spaces.

**Comfortable**

- Non-slip grips.
- Ratchet lock system for reduced effort.

Capacity 18 to 54 mm.



Tools for self-tightening spring clips

▣ DM.MUB Spring clamp pliers



- Fits self-tightening spring clips diameter: 18 to 54 mm.
- Can be used one-handed.
- Non-slip bi-material handle for a better grip.
- Rack system for reduced effort.
- Sheath length: 560 mm.
- Total length: 780 mm.
- DM.MUB-RN1: Sleeve repair kit, cable + jaws (7373280). Weight: 500 g.

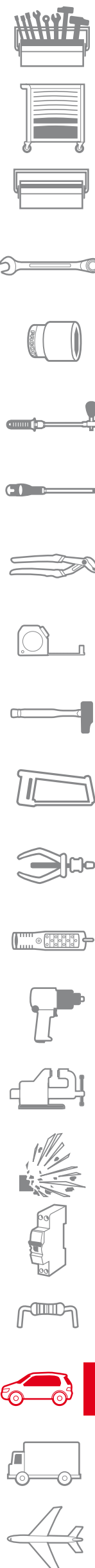



## Self-tightening clamp pliers



- For hose clamps on cooling, heating, fuel or screen-washer.
- DM.25: slip-joint model.
- DM0.27: long-reach model with lock and pivoting jaws.
- DM0.29: standard-reach model with lock and pivoting jaws.

	d [mm]	Dimension [mm]	ΔΔ [g]
<b>DM.25</b>	12..60	275 x 55 x 20	400
<b>DM.27</b>	15..56	275 x 60 x 25	395
<b>DM.29</b>	15..56	215 x 60 x 25	340

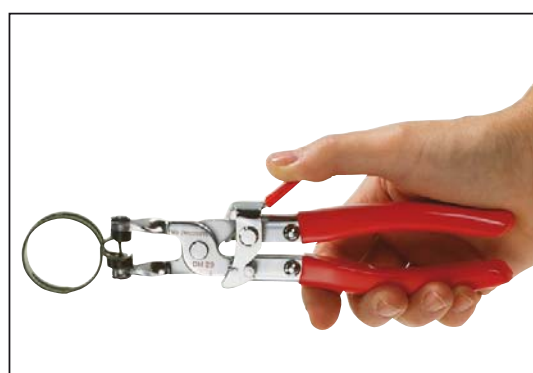

## Flexible screwdriver

### Flexible nut drivers (6 point)



- For loosening and tightening hose clamps.

	d [mm]
<b>D.133A6</b>	6
<b>D.133A7</b>	7
<b>D.133A8</b>	8
<b>D.133A10</b>	10

Cooling circuit

Cooling system tester

935A - COOLING SYSTEM FILLER

ESSENTIAL FOR THE LATEST ENGINES

Safe

- Some manufacturers are doing away with cooling system bleed screws and imposing vacuum filling systems instead.
- The 935A depressurises the cooling system, ensuring perfect bleeding.

Cost effective

- Fills and bleeds the air from cooling systems quickly and without wasting new coolant.



935A Vacuum cooling circuit fillers



- For total filling of cooling circuits also without bleed screw.
  - Supplied in a plastic case (complete with 5 can adaptors).
- Weight: 1.960 kg.

778A Anti-freeze hydrometer



- Measures antifreeze levels in engine coolant.
  - Two scales for cold or warm engines.
  - Dimensions (L. x W): 350 x 42 mm.
- Weight: 90 g.

780A Refractometer



- Two measuring scales:
    - 0 to -50°C (5°C graduations)
    - Battery fluid density: 1,10 to 1,40 kg/l.
  - Simple screw recalibration using distilled water.
  - Supplied in case with sampling pipette and screwdriver.
  - Dimensions (L. x W. x H.): 70 x 235 x 700 mm.
- Weight: 550 g.

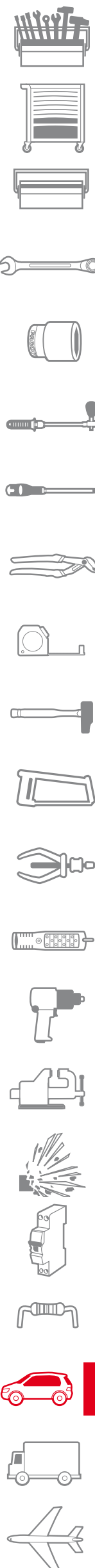

## Hose clamps

### ■ Screw-type hose clamps



- Metal structure.
- Applications:
  - Cooling circuit.
  - Fuel circuit.
  - Air circuit.

➤	d [mm]	l [mm]	ΔΔ [g]
<b>DM.90</b>	27	65	190
<b>DM.91</b>	45	85	240

### ■ Hose clamps



- Hoses are clamped shut instantly without damage.
- Plastic structure.

➤	d [mm]	l [mm]	ΔΔ [g]
<b>DM.33</b>	8...15	160	170
<b>DM.34</b>	15...28	180	190
<b>DM.34GM</b>	25...55	205	210



## Cylinder head - valves

### ■ U.13L Valve lifter



- For removing valve springs.
  - Complete with jaws ref U.13B.
  - Dimensions (L. x W. x H.): 265 x 365 x 20 mm.
- Weight: 1.14 kg.



▣ Collet clamp and cup



- To fit U.13L, the collet replacing the screw, with the cup inserted between the 2 jaws.
- U.13DB: For 16-valve engines.

➤	d [mm]	ΔΔ [g]
<b>U.13DB</b>	30	335
<b>U.13DC</b>	33	340

▣ U.43LA Slide-hammer valve lifter



- For removing valve springs.
- The slide hammer is used to free split collets.
- Diameter: 34 mm.
- Dimensions (L. x W. x H.): 200 x 390 x 36 mm.
- Weight: 1.385 kg.

▣ U.43LA16A Collet clamp



- For 16-valve engines.
- Fits U.43LA.
- Length: 54 mm.
- Diameter: 29 mm.
- Weight: 55 g.

▣ U.43 Cylinder-head rest



- Adjustable distance between feet.
- Designed for easy use of valve lifters U.13L - U.43LA.
- Dimensions (L. x W. x H.): 215 x 500 x 165 mm.
- Weight: 1.8 kg.

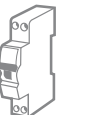
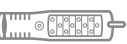
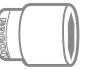
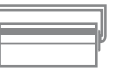

## DM.7 Special pliers



- For removing valve guide seals.
  - Length: 245 mm.
  - Finish: Nickel, burnished jaws.
- Weight: 350 g.

## DM.10A Valve stem seal pliers



- For removing valve guide seals.
  - Dimensions (L. x W. x H.): 235 x 80 x 15 mm.
- Weight: 135 g.

## U.54A Air-operated valve grinder

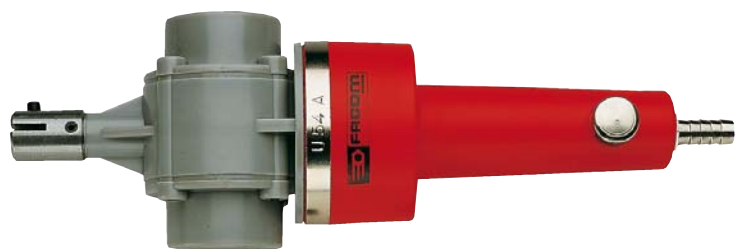

- Working pressure: 8 bar.
  - Air consumption: 0.08 m<sup>3</sup>/min.
  - Supplied with 2 suction cups (diam.: 22 and 33 mm).
  - Dimensions (L. x W. x H.): 280 x 90 x 70 mm.
- Weight: 800 g.
- Suction cup 22 mm: U.54AV1.
  - Suction cup 33 mm: U.54AV2.
  - Suction cup 30 mm: U.54AV3.
  - Suction cup 45 mm: U.54AV4.

## D.51 Valve grinder



- Suction pads: 19 - 22 mm.
  - Dimensions (L. x W.): 235 x 22 mm.
- Weight: 30 g.

▣ **D.1** Scraper



- For deburring and scraping off gasket debris.
- Triple-edge blade.
- Dimensions (L. x W. x H.): 200 x 25 x 20 mm.
- Weight: 105 g.

▣ **D.34J7** 7-piece set of 6-spline bits 1/2"



- Comprising: D.34B7 - D.34B7L - D.34B9L - D.34B10 - D.34B12L - D.34B14L - D.34B16L.
- Supplied on a rack.
- Weight: 900 g.

▣ **D.34B** - Long-reach 6-spline bits

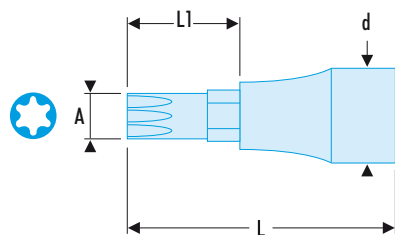

▣	A [mm]	d [mm]	L1 [mm]	l [mm]	ΔΔ [g]
<b>D.34B7</b>	7	7	15	60	60
<b>D.34B7L</b>	7	7	63	100	100
<b>D.34B9L</b>	9	9	63	100	100
<b>D.34B10</b>	10	10	15	60	60
<b>D.34B12L</b>	12	12	63	100	100
<b>D.34B14L</b>	14	14	63	100	100
<b>D.34B16L</b>	16	16	63	100	100

▣ **MOD.SHP** 12-piece set of 1/2" square-drive sockets with long-reach monoblock bits



- Sockets for light vehicle cylinder head screws.
- SX.LA 40 - 45 - 55 - 70.
- SHP.LA 5 - 6 - 7 - 8.
- SV.LB 6 - 8 - 10 - 12.
- Thermoformed module PL.336.
- Weight: 1.630 kg.

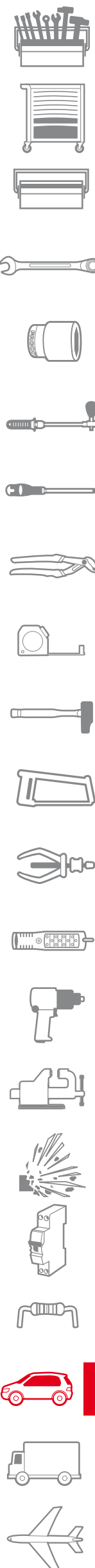



## MOD.TX1 Set of Torx® socket wrenches and bits



- J.235: Bit holder.
  - R0.235: 1 bit holder socket 1/4".
  - S.236: 1/2" bit holder socket.
  - EX.2 40 - 45 - 50 - 55: 5/16 bits.
  - EXR. 10 - 15 - 20 - 25 - 30 - 40: 1/4 bits.
  - JTX. 8 - 10 - 12 - 14 - 16: 3/8" sockets.
  - STX 18 - 20: 1/2" sockets.
  - 59TX 6 x 8 - 10 x 12 - 14 x 18 - 20 x 24: Ring wrenches.
  - Thermoformed module PL.360.
- Weight: 995 g.

## SV.J5 5-piece set of drive bits for spline socket head (XZN) bits 1/2"



- Comprising the bits: SV.14LB - SV.12LB - SV.10LB - SV.8LB - SV.6LB.
  - Bit length: 64 mm.
  - Supplied on a rack.
- Weight: 670 g.

## SE.1A 20-piece set of short-reach bits



- Including:
  - 1 socket holder bit - square 1/2", diam.: 5/16".
  - 5 6-point bits: 4 to 10 mm.
  - 8 Torx® bits: n°20 to n°55.
  - 4 XZN bits: 6 to 12 mm.
  - 3 bits Pozidriv® bits: n°2 to n°4.
- Weight: 475 g.

Angular range

**TORQUE  
TIGHTENING**

**WRENCHES AND DRIVES**

**E.306 AND E.316 SERIES**

- 9 torque and/or angle values can be preset.
- 250 results can be saved, downloaded via USB.

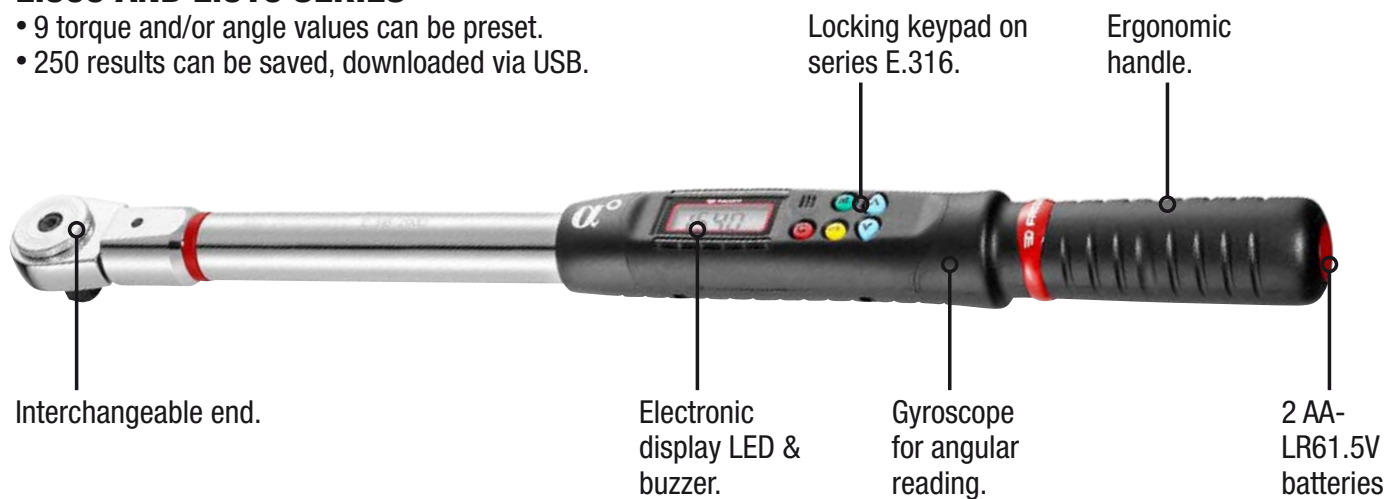

**SERIES E.506**

- 9 torque and/or angle values can be preset.
- 50-result memory.



**SERIES E.406**

- 9 preset angle values.
- 50-result memory.

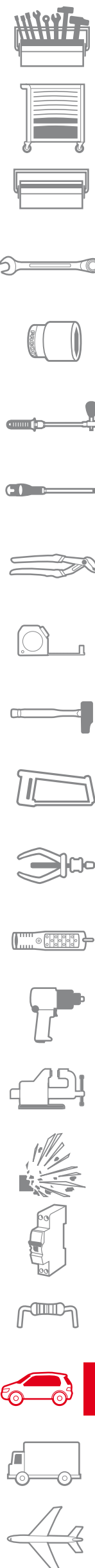

## Digital control tools

### ▣ E.506-135S E.506 - Torque and angled adapter



NF EN ISO 6789, ISO 6789, DIN EN ISO 6789

- Drive bit 1/2".
  - Accuracy:
    - Torque:  $\pm 3\%$  between 20% and 100% wrench capacity.
    - Angle:  $\pm 2^\circ$ .
  - Measuring mode: peak or track follower.
  - Cycle counter.
  - Locking keypad (the operator has access only to program choices and memorise results).
  - Measuring unit: N.m, ft.lb, In.lb, kg.cm, deg.
  - Presetting possible of 9 torque and/or angle values.
  - Memory 50 values.
  - Length: 80 mm.
  - Supplied in plastic case with calibration certificate.
- Weight: 268 g.

### ▣ E.406 E.406 - Angle adapter



- Accuracy:  $\pm 2^\circ$ .
  - Angular range: 1 - 360°.
  - Measuring unit: degree.
  - Presetting possible of 9 torque and/or angle values.
  - Memory 50 values.
  - Supplied in plastic case with calibration certificate.
- Weight: 98 g.

## Analog control tools

### ▣ DMP.360L Angular torque gauge 1/2" drive



- Including:
    - 3 bits (length: 24 - 45 - 65 mm).
    - 1 flexible.
    - 1 pair of pliers.
    - 1 magnet.
  - Dimensions (L. x W. x H.): 375 x 180 x 145 mm.
- Weight: 550 g.



DM - Angular torque gauge



- 2° graduations.
- Male and female square drive.
- Fixed point by flexible with magnet.

DM	d [mm]	L [mm]	l [mm]	Square ["]	ΔΔ [g]
DM.360	63	410	410	1/2	350
DM.370	73	430	430	3/4	550

D.360L Side-graduated angular torque gauge 1/2" drive bit

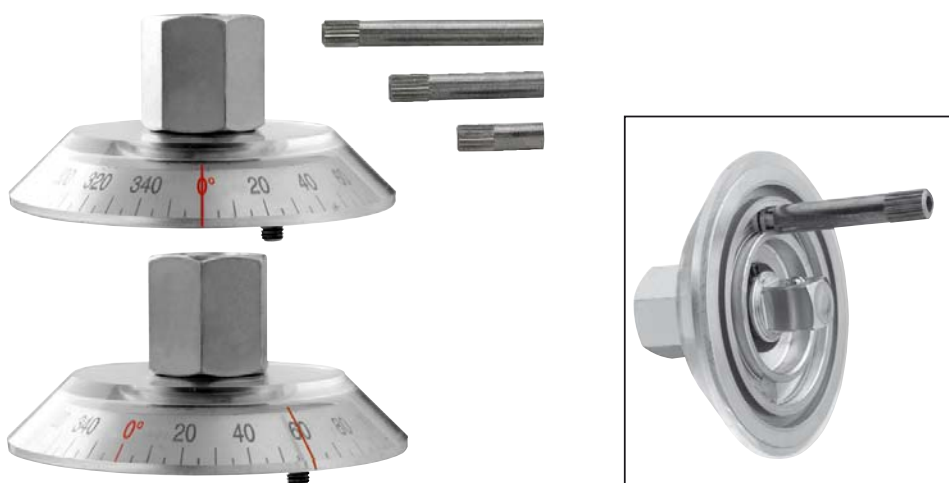

- Lateral reading tapered drum for maximum legibility.
  - Double index (red line) for presetting. To tighten, simply align the two markers. Ideal with low lighting.
  - 2° resolution.
  - Supplied with a limit stop (length: 24 - 45 - 65 mm).
- Weight: 414 g.

DM.360L Side-graduated angular torque gauge with flexible arm and magnet 1/2"



- Supplied with a flexible arm and a magnet.
- Weight: 500 g.

Pistons - piston rings

Piston ring compressors



- For easy insertion of piston into cylinder bore and even compression over full ring length.
- Ratchet mechanism.
- Complete with key (length: 6 mm).

DM	d [mm]	L [mm]	l [mm]	ΔΔ [g]
750.TB	55...110	80	80	260
750.KB	100...160	80	80	300

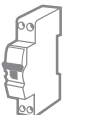
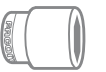

## ▣ Piston ring pliers



- Even expansion over full ring length.
- Quick and easy to use.

➤	d [mm]	l [mm]	ΔΔ [g]
<b>751.T</b>	45...100	210	280
<b>751.K</b>	90...150	255	330

## Removal

### Lambda probe

## ▣ Lambda probe wrench and sockets



- For use on lambda probes.
- Featuring a slot for the connecting lead.
- Square drive bit 1/2".
- N.B. Lambda probes must be torqued to manufacturers specified values.

➤	d [mm]	ΔΔ [g]
<b>D.145A</b>	33 x 85	200
<b>D.146A</b>	33 x 85	230

## Maintenance

## ▣ DE.C PSA exhaust collar pliers



- Bi-material grip, for opening exhaust collars.

**804** Round tip metric thickness gauges



- Set of 19 feeler gauges (round tip): 4/100 --> 100/100 mm.
- Blade length: 90 mm.
- Weight: 60 g.

**804.AM** Anti-magnetic metric thickness gauges

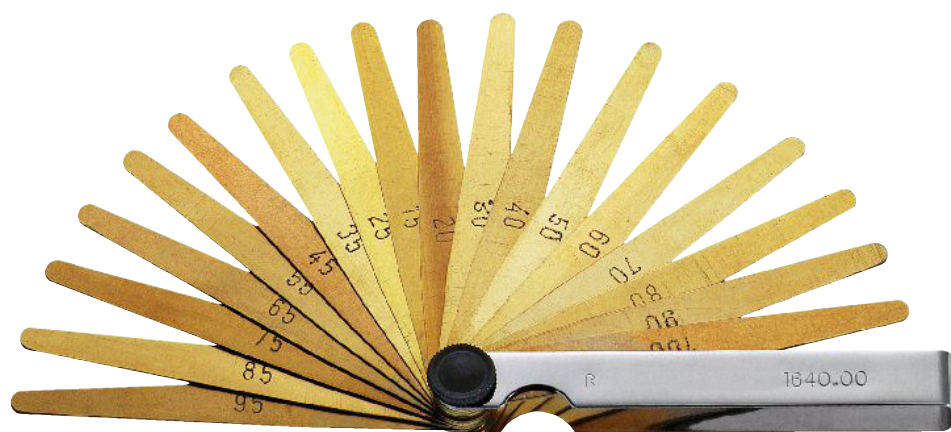

- Set of 19 feeler gauges (tapered tip): 10/100 --> 100/100 mm.
- Blade length: 100 mm.
- Brass blades.

**804.P** Sharp tip metric thickness gauges



- Set of 19 feeler gauges (tapered tip): 4/100 --> 100/100 mm.
- Blade length: 90 mm.

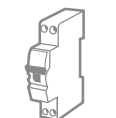



## 804.U Inch thickness gauges



- Set of 26 feeler gauges (tapered tip): 15/10000 --> 250/10000 inches.
- Blade length: 3"1/2 (88.9 mm).

## 804.L Long metric thickness gauges



- Set of 19 feeler gauges (round tip): 4/100 --> 25/100 mm.
- Blade length: 150 mm.

## D.110 Spark plug fitter



- Helps engage a spark plug thread in any location, regardless of the screw head.
- Square drive: 6 --> 11 mm.
- Length: 305 mm.
- Weight: 55 g.

## DT SERIES TIMING ADJUSTMENT

# ACCURACY AND SPEED

### FOR SAFE ACCURATE TIMING ADJUSTMENT.

The ignition timing of modern multi-valve petrol and high pressure diesel engines requires accurate adjustment

Inaccurate adjustment can lead to :

- over-consumption, engine breakage, malfunction, pollution, etc.

On many modern twin-cam engines, at least one of the two pulleys will turn when the timing belt is removed :

- the method of aligning timing marks is no longer appropriate.

Poor timing adjustment will at the very least cause engine malfunction, requiring the work to be restarted :

- the use of timing tools really does save time.

### FOR ALL OF THESE REASONS, IT IS ESSENTIAL TO IMMOBILISE THE ENGINE WHEN READJUSTING TIMING OR CHANGING THE TIMING BELT.

### THE RIGHT EQUIPMENT ENSURES PROFITABILITY

With a separate kit for each make or range of engines, you only buy the tools that you need.

The kits are defined according to the European vehicle fleet and timing belt sales statistics.

### A CLEAR AND PRECISE METHOD.

Each kit comes with precise instructions that are sufficient for changing a timing belt or chain, or for adjusting the timing.

Regular updates : See [www.facom.com](http://www.facom.com) for our latest products and applications.

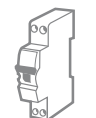

## Diesel engine timing kit

### Timing kits

#### DT.FIAT-D1 FIAT timing kit - Diesel engines no.1



- Makes: FIAT, ALFA ROMEO, LANCIA, FORD, OPEL, SUZUKI.
- Timing chain diesel engine: 1.3 MULTIJET - 1.3 CDTi - 1.3 TDCi - 1.3 JTD/MULTIJET.
- Models:
  - ALFA: Mito.
  - FIAT: 500, Doblo, Doblo Cargo, Fiorino, Grande Punto, Idea, Linea, Panda, Punto, Punto Evo, Qubo, Strada Pick-up.
  - LANCIA: Musa, Ypsilon.
  - OPEL: Agila, Astra H, Combo C, Corsa C, Corsa D, Meriva, Tigra B.
  - SUZUKI: Ignis, Swift, Wagon/Wagon R+.
  - FORD: Ka.
- Dimensions (L. x W. x H.): 325 x 265 x 77 mm.
- Supplied in plastic case.

#### DT.FIAT-D2 FIAT timing kit - Diesel engines no.2



- Makes: FIAT, LANCIA, ALFA ROMEO, OPEL.
- Timing belt diesel engine: 1.6 JTDM 16V - 1.6 MULTIJET - 1.9 MULTIJET - 1.9 CDTi (engine Z19) - 1.9 JTD - 1.9 JTD/MULTIJET - 2 JTDM 16V - 2 MULTIJET - 2.4 JTD.
- Models:
  - ALFA: 147, 156, 159, 166, Brera, Crosswagon, Giulietta, GT, Mito, Spider.
  - LANCIA: Delta, Kappa, Lybra, Musa, Thesis.
  - OPEL: Astra H, Signum, Vectra C, Zafira B.
  - FIAT: Brava, Bravo, Cromia, Doblo, Doblo Cargo, Grande Punto, Idea, Linea, Mareva, Marengo, Multipla, Palio Weekend, Punto, Punto Evo, Seidici, Stilo, Strada Pick-up.
- Dimensions (L. x W. x H.): 250 x 205 x 45 mm.
- Supplied in plastic case.

#### DT.FIAT-P1 FIAT timing kit - Petrol engines



- Makes: FIAT, ALFA ROMEO.
- Petrol engine: 0.9 TWINAIR - 1.4 MULTIAIR.
- Models:
  - ALFA: Giulietta, Mito.
  - FIAT: 500, Punto Evo.
- Dimensions (L. x W. x H.): 325 x 265 x 77 mm.
- Supplied in plastic case.



## DT.FORD-D1 FORD timing kit - Diesel engines



- Makes: FORD, MAZDA.
- Timing belt diesel engine: 1.4 TDCi - 1.6D -1.6 TDCi - 1.8 D - 1.8 D TURBO - 1.8 TDCi - 1.9 TDI PD - 2.0 TDCi - 2.2 TDCi - 2.5 D - 2.5 TCI - 2.5 D TURBO.
- Models:
  - FORD: C-Max, Courier, Escort, Fiesta, Fiesta Econetic, Focus, Focus C-MAX, Fusion, Galaxy, Mondeo, Orion, Tourneo Connect, Transit, Transit Connect.
  - MAZDA: 2, 3, 5.
- Dimensions (L. x W. x H.): 325 x 265 x 77 mm.
- Supplied in plastic case.

## DT.FORD-P1 FORD timing kit - Petrol engines



- Make: FORD.
- Timing belt petrol engine: 1.25 - 1.4 - 1.6 - 1.6 Ti-VCT - 1.6 SCTi EcoBoost - 1.8 - 2.0.
- Models:
  - FORD: C-Max, Cougar, Fiesta, Focus, Focus C-MAX, Fusion, Grand C-max, Mondeo, Puma, Tourneo Connect, Transit Connect.
- Dimensions (L. x W. x H.): 325 x 265 x 77 mm.
- Supplied in plastic case.

## DT.OPEL-D1 OPEL timing kit - Diesel engines



- Make: OPEL.
- Diesel engine: 1.5 D - 2.0 DTi (chain) - 2 D TURBO - 2.2DTi (chain) - 2.2D - 3.0 D TURBO - 3.1 D TURBO.
- Models:
  - OPEL: Astra G, Cavalier, Frontera B, Midi, Monterey, Omega B, Signum, Sintra, Vectra B, Vectra C, Zafira A.
- Dimensions (L. x W. x H.): 325 x 265 x 77 mm.
- Supplied in plastic case.

## DT.OPEL-P1 OPEL timing kit - Petrol engines



- Make: OPEL.
- Petrol engine: 1.0/1.2/1.4 ("X" & "Z" chain engines) - 1.6 - 1.6 OPC/VXR - 1.8 - 2.0 TURBO.
- Models:
  - OPEL: Agila, Ascona, Astra, AstraMax, Belmont, Cavalier, Combo, Corsa, Insignia, Kadett-E, Meriva, Nova, Signum, Tigra, Vectra, Zafira.
- Dimensions (L. x W. x H.): 325 x 265 x 77 mm.
- Supplied in plastic case.

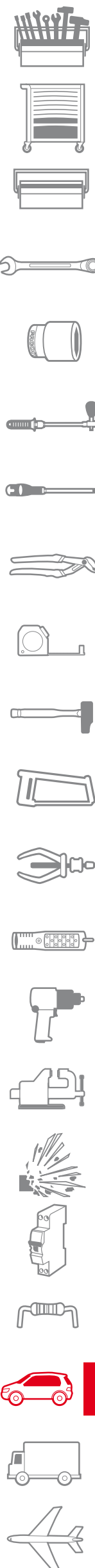

## DT.PSA-D1 PSA timing kit - Diesel engines



- Makes: CITROEN, PEUGEOT.
- Timing belt diesel engine: 1.4 HDi - 1.5 D - 1.6 HDi - 1.9 D - 2.0 HDi - 2.0 DHDi 16V - 2.2 HDi - 2.5 D TURBO.
- Models:
  - CITROEN: AX, Berlingo, Bipper, C1, C2, C3, C4, C5, Dispatch, Nemo, Jumper, Jumpy, Relay, Saxo, Xsara.
  - PEUGEOT: 106, 107, 205, 206, 207, 306, 307, 308, 309, 405, 406, 407, 605, 607, 806, 807, 1007, 3008, 5008, Boxer, Expert, Partner.
- Dimensions (L. x W. x H.): 400 x 335 x 95 mm.
- Supplied in plastic case.

## DT.PSA-P1 PSA timing kit - Petrol engines



- Makes: CITROEN, PEUGEOT.
- Timing belt petrol engine: 1.0 - 1.1 - 1.4 - 1.6 - 1.6 VTS - 1.8 16V - 2.0 - 2.0 16V - 2.2.
- Models:
  - CITROEN: AX, Berlingo, BX, C2, C3, C3 Pluriel, C4, C5, C8, C15, Dispatch, Evasion, Jumper, Jumpy, Relay, Saxo, Synergie, Xantia, XM, Xsara, ZX.
  - PEUGEOT: 106, 205, 206, 306, 307, 309, 405, 406, 407, 605, 607, 806, 807, 1007, Boxer, Expert, Partner/Ranch.
- Dimensions (L. x W. x H.): 325 x 265 x 77 mm.
- Supplied in plastic case.

## DT.REN-D1 RENAULT timing kit - Diesel engines



- Makes: RENAULT, NISSAN, OPEL.
- Timing belt diesel engine: 1.5 dCi - 1.9 dCi - 1.9 dTi - 1.9CDTi (F9Q engines) - 2.2 dCi - 2.2 DTi - 2.5 dCi - 2.5 CDTi.
- Models:
  - NISSAN: Almera, Cube, Interstar, Juke, Kubistar, Micra, Note, NV200, Primastar, Primera, Qashqai, Tiida.
  - OPEL: Movano-A, Vivaro.
  - RENAULT: Clio, Espace, Kangoo, Laguna, Logan (LSO), Megane Scenic, Modus, Scenic, Scenic RX4, Traffic.
- Dimensions (L. x W. x H.): 325 x 265 x 77 mm.
- Supplied in plastic case.

## DT.REN-P1 RENAULT timing kit - Petrol engines



- Make: RENAULT.
- Timing belt petrol engine: 1.2 16V - 1.4 - 1.4 16V - 1.6 - 1.6 16V - 1.8 - 2.0 - 2.0 IDE - 2.0 16V.
- Models:
  - RENAULT: Clio, Espace, Gran Scenic, Kangoo, Laguna, Logan, Megane, Megane Scenic, Modus, Twingo, Wind.
- Dimensions (L. x W. x H.): 325 x 265 x 77 mm.
- Supplied in plastic case.

## DT.VAG-D1 VAG timing kit - Diesel engines no.1



- Makes: AUDI, SEAT, VW, SKODA.
- Timing belt diesel engine: "TDI PD": 1.2 - 1.4 - 1.9 - 2.0 - "TDI CR": 1.6 - 2.0 - "SDI": 2.0.
- Models:
  - AUDI: A2, A3, A4, A5, A6, Q5.
  - SEAT: Altea, Arosa, Cordoba, Exeo, Ibiza, Leon, Toledo.
  - SKODA: Fabia, Octavia, Praktik, Roomster, Superb, Yeti.
  - VW: Beetle, Bora, Caddy, Eos, Fox, Golf, Golf Plus, Jetta, Lupo, Passat, Polo, Scirocco, Sharan, Tiguan, Touran, Transporter.
- Dimensions (L. x W. x H.): 325 x 265 x 77 mm.
- Supplied in plastic case.

## DT.VAG-D2 VAG timing kit - Diesel engines no.2



- Additional tooling kit for the timing case DT.VAG-A.
- Makes: Audi, VW, Seat, Skoda.
- Timing belt diesel engine: "TDI PD": 1.9 - 2.0 with oval crankshaft pulley.
- Models:
  - AUDI: A3, A4, A6.
  - SEAT: Altea, Cordoba, Ibiza, Leon, Toledo.
  - SKODA: Fabia, Octavia, Roomster, Superb.
  - VW: Beetle, Bora, Caddy, Eos, Golf, Jetta, Passat, Polo, Scirocco, Sharan, Touran, Transporter.
- Dimensions (L. x W. x H.): 147 x 77 x 42 mm.
- Supplied in blister.

## DT.VAG-P1 VAG timing kit - Petrol engines no.1



- Makes: AUDI, SEAT, VW, SKODA.
- Chain petrol engine: 1.2 (6V & 12V 3-cylinder engine) - 1.4 FSI - 1.4 TSI - 1.6 FSI.
- Models:
  - AUDI: A3.
  - SEAT: Cordoba, Ibiza.
  - SKODA: Fabia, Praktik, Roomster.
  - VW: Eos, Fox, Golf, Jetta, Passat, Polo, Scirocco, Sharan, Tiguan, Touran.
- Dimensions (L. x W. x H.): 325 x 265 x 77 mm.
- Supplied in plastic case.

## DT.VAG-PTD1 VAG timing kit - Petrol engines no.2



- Makes: AUDI, SEAT, VW, SKODA.
- Timing belt petrol engine: 1.4 16V - 1.4 FSI - 1.6 - 1.6 16V - 1.6 FSI - 1.8 - 1.8 TURBO - 2.0 - 2.0 TFSI - 2.0 FSI.
- Timing belt diesel engine: 1.7 D - 1.7 SDI - 1.9 D - 1.9 TDI - 1.9 SDI - 1.9 D TURBO - 2.5 TDI (rotating pump 6-cylinder engine).
- Models:
  - AUDI: A2, A3, A4, A6, A8, Allroad, S3, TT.
  - SEAT: Alhambra, Altea, Arosa, Cordoba, Ibiza, Inca, Leon, Toledo.
  - SKODA: Fabia, Felicia/Van/Pick Up, Octavia, Superb n.
  - VW: Beetle, Bora, Caddy, Corrado, Fox, Golf, Jetta, Lupo, Passat, Polo, Scirocco, Sharan, Touran, Transporter Vento.
- Dimensions (L. x W. x H.): 325 x 265 x 77 mm.
- Supplied in plastic case.

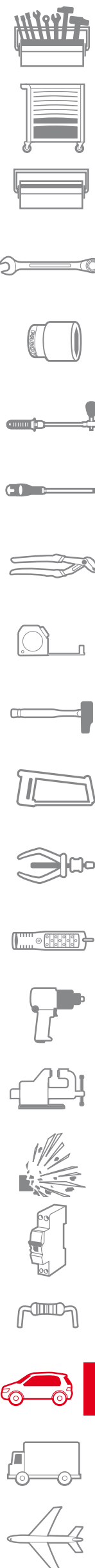



### ▣ D.86 Flywheel stay



- To lock the flywheel crown gear.
  - Dimensions (L. x W. x H.): 30 x 46 x 25 mm.
- Weight: 21 g.

## Pulleys - sprockets - belts

### Belt tension testing

#### DT.HERTZ - BELT TENSION TESTER

##### THE RIGHT TENSION GUARANTEED

##### Avoid breakage

The correct belt tension is essential :

- If insufficiently tight,
  - The auxiliary belts will slip and become worn.
  - Timing belts may jump (engine breakdown)
- If over-tightened,
  - The forces will damage the rollers and pumps.
  - Risk of premature belt failure.

##### Easy, accurate testing

Simply place the ultra-compact sensor against the belt and induce a vibration in the belt (like a guitar string). Compare the displayed reading with the recommended value in the guide.

##### Regular updates.

The DT.DOC guide is regularly updated. See [www.facom.com](http://www.facom.com) for the reference number of the latest version.



### ▣ DT.HERTZ Multi-make electronic belt tension-meter



- Quickly and easily checks the tension of timing and auxiliary belts.
  - Can be used for all belts on the market.
  - Compact, manoeuvrable tool, can be operated one-handed.
  - Cable length: 1,200 mm.
  - Supplied in a plastic case, dim. (L. x W. x H.): 135 x 50 x 28 mm; with reference value guide.
- Weight: 150 g.

## DM.16 Multi-make electronic belt tension-meter

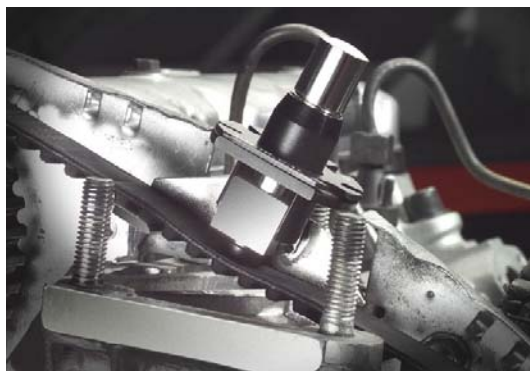

- For checking timing belt tension.
- Comes in a plastic case with 6 interchangeable ends, a belt thickness measuring gauge and a calibration checking gauge.
- Dimensions (L. x W. x H.): 170 x 120 x 50 mm.
- Weight: 420 g.

## Timing pulley and belt fitting and removal

### DM.50 Multi-diameter damper pulley puller

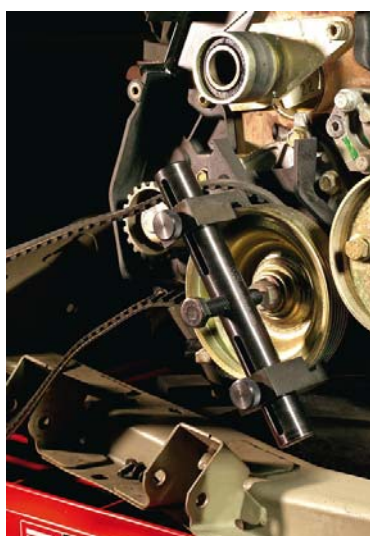

- Removes crankshaft multi-groove pulleys without damage.
- Lockable, adjustable legs to fit the various pulley sizes.
- Compact design for working on engine in situ.
- Pulley capacity: 45 to 175 mm.
- No groove: 3.56 mm.
- Weight: 1.120 kg.

### DM.17A Multi-diameter timing and injection pump pulley puller

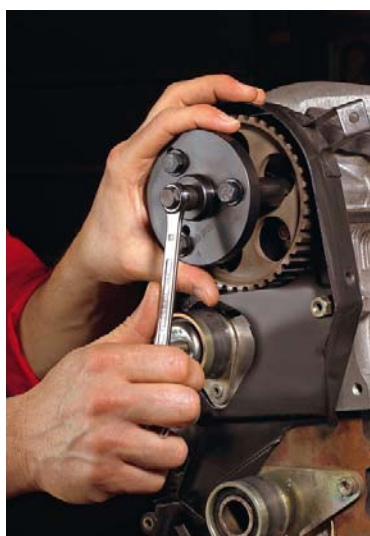

- Removes pulleys without damage.
- Adjustable legs adapt to differing pulley diameters.
- Compact design for working on engine in situ.
- Dimensions (L. x W.): 90 x 110 mm.
- Weight: 925 g.

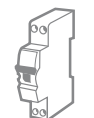

## DT.TW - BELT TENSIONER WRENCHES

### Handy

- One "arm", 5 dimensions.
- Suited to most vehicles on the market.
- Angled wrenches for optimised access
- Mechanical wrench locking on the arm.

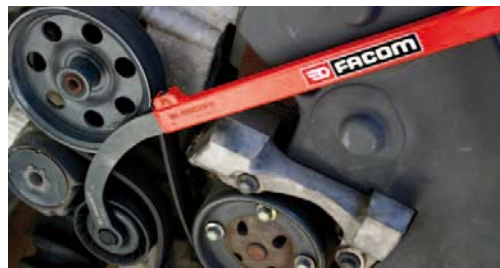

Hand and fast hanging system

### DT.TW 5-piece set of belt-tensioner nut wrenches



- To turn tensioner belts, timing pulley nuts and auxiliary elements even in confined positions.
  - Wrench easy fastening / unfastening system integral to the handle.
  - Comes with 445 mm handle and 5 ring wrenches 13 - 15 - 16 - 17 - 19 mm.
- Weight: 1.350 kg.

### DT.CLE Universal pulley wrench



- For blocking, cranking and holding camshaft and injection pump pulleys.
  - Length: 410 mm.
- Weight: 950 g.

### DM.8 Pulley stay



- For blocking multi-groove pulleys.
  - Capacity: 40 to 140 mm.
  - Handle length: 350 mm.
- Weight: 780 g.



DM.APR Alternator pulley kit



- For fitting and removing the alternator pulley.
- 13 tools.
- Comprising:
  - 2 TORX bits T40 - T50.
  - 2 XZN bits M8 - M10.
  - 2 6-point bits 8 - 10mm.
  - 1 TORX COMBI socket.
  - 1 XZN COMBI socket.
  - 2 special fitting / removal sockets.
  - 1 double 6-point socket.
  - 1 square / 6-point adapter.
- Supplied in a plastic case, dim. (L. x W. x H.): 330 x 140 x 65 mm.
- Weight: 1.620 kg.

DT.SFB - FLEXIBLE BELT FITTING/REMOVING TOOL

Handy

- Tool suited to simple and double diameter pulleys.
- No adjustment required for fitting or removing.
- Suited to all types of elastic belts: A/C, alternators, belts.



DT.SFB Flexible belt kit



- For fitting / removing flexible service belts (A/C, power steering, alternator) without tensioner.
- Comprises two special tools for fitting and removing the belt.
- Special profile allowing use also on different diameter pulleys.
- Compact dimensions for access into the engine compartment.
- No regulations required for use on different pulleys.
- Supplied in a plastic case, dim. (L. x W. x H.): 210 x 120 x 55 mm.
- Weight: 400 g.



## Gearbox and clutch

### ▣ U.25A Universal clutch aligner no.1



- Set of bushes and cones for centring clutch discs.
- Contains:
  - 1 guide handle.
  - 11 bushes, diam. 12 to 22 mm.
  - 3 cones, diam. 25 - 30 - 40 mm.
- Pressed-steel case.
- Dimensions (L. x W. x H.): 322 x 136 x 53 mm.
- Weight: 1.140 kg.

### ▣ DM.30 Universal clutch aligner no.2

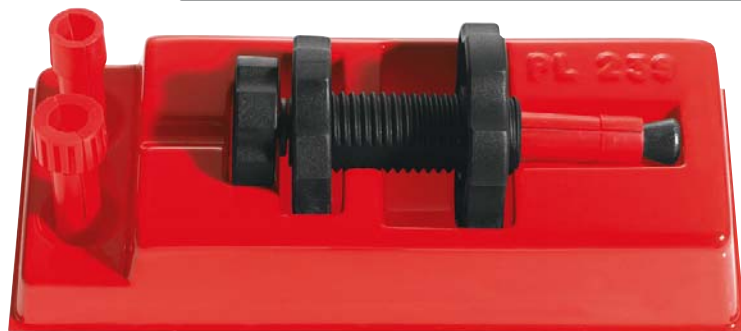

- The tool centres and holds the clutch disc and mechanism.
- Supplied complete with 3 expanding clamps:
  - Clamp for diameter 18 to 21 mm.
  - Clamp for diameter 22 to 25 mm.
  - Clamp for diameter 14.5 to 18 mm.

### ▣ 470 Inside and outside circlip® pliers



- Interchangeable tips for:
  - Diameter 8 to 63 mm for inside Circlips®.
  - Diameter 3 to 63 mm for outside Circlips®.
- Contains:
  - 469.PA: Inside circlip® pliers.
  - 467.PA: Outside circlip® pliers.
  - 82H.2.5: Key.
  - Set of 18 removable tips.
  - Plastic box.
- Weight: 1.500 kg.

### ▣ 467.01AJ2 Set of spare screws



- For Ref.: 467 - 469 - 470.

### ▣ DM.14 Transmission collar clamp

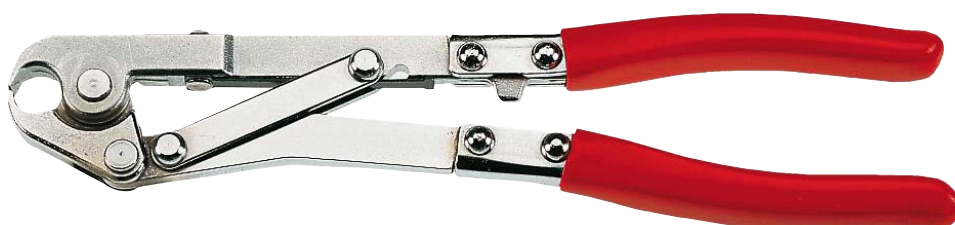

- To crimp collars on transmission bellows.
- For OETIKER collar.
- Dimensions (L. x W. x H.): 280 x 50 x 20 mm.
- Weight: 475 g.

Inspection

DF.18-01 Disc brake vernier caliper



- Vernier caliper for checking the thickness of brake discs.
  - Accurate, error-free reading.
  - Measurements can be taken with wheel in place (if no protective bodywork).
  - Can quickly demonstrate to customers the need for changing brakes.
  - Capacity 0 to 50 mm, outer thickness measurement of the disc brakes of cars and LCV's.
  - Nose length: 50 mm.
  - 0.1 mm reading increments.
  - Mechanical memory device.
  - Supplied in a reinforced fabric case with serial number for traceability in ISO certified workshops.
- Weight: 250 g.

DF.19-01 Drum brake vernier caliper



- Capacity and reading to suit requirements of car, LCV and HGV applications.
  - Capacity: 40 to 300 mm, inner thickness measurement of brake drums on cars and LCVs.
  - Nose length: 100 mm.
  - 0.20 mm reading increments internal drum measurements for cars and LCVs.
  - 0.10 mm increments for readings between tips.
  - Supplied in a reinforced fabric case with serial number for traceability in ISO certified workshops.
- Weight: 700 g.

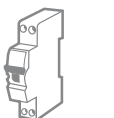
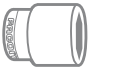
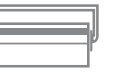



## DF.16 - BRAKE FLUID TESTER

### QUICK BRAKE FLUID TESTER

**A quick, cost-effective analysis.  
For the safety of your customers.**

- Water in the brake fluid can turn into vapour under severe or repeated braking, making the brake pedal ineffective.

**The boiling point of brake fluids must exceed a specified minimum value :**

<b>DOT 3</b>	140°C
<b>DOT 4</b>	155°C
<b>DOT 5.1</b>	180°C



### DF.16 Brake fluid tester



- For testing brake fluids (DOT3 - DOT4 - DOT5.1).
- Measures brake fluid boiling point.
- Automatic test lasting up to 1 min.
- LCD display.
- °C / °F switch.
- Accuracy: 3%.
- Power supply: 12 V (vehicle battery).
- Plastic case.
- Dimensions (L. x W. x H.): 350 x 285 x 80 mm.

## Diagnostics and bleeding

**BRAKE BLEEDING : A SAFETY REQUIREMENT****FAST AND EFFICIENT**

Brake bleeding is an operation that takes 10 to 15 minutes with a modern appliance such as the DF.20-100 or DF.21. A single operator is able to fill and bleed the brake system.

A profitable operation for the workshop. A brake bleeder is very quickly cost-effective, and its cost is absorbed in under 50 operations.

**SAFETY**

It is recommended to replace the brake fluid once every two years or after 40,000 km depending on the manufacturer.

**DF.20-100 Brake and clutch system bleeder**

- For bleeding car and LCV brakes and HGV clutches.
  - ABS compatible.
  - Portable, stand-alone appliance (12 V).
  - Automatic pressure regulator (automatically keeps the working pressure below 2 bars for ABS systems).
  - Reservoir with visible level and min. level indicator.
  - Capacity: 5 l.
  - Body: stainless/ABS.
  - Length of hose and power cable: 4 m.
  - Contains:
    - 1 multi diameter plug for using the bleeder on vehicles with a bayonet plug (DF.20-12).
    - 1 standard screw plug.
    - 1 fluid collector with attaching chain.
- Weight: 11 kg.

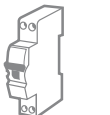
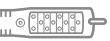
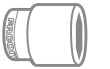



## DF.21 Adjustable-pressure electronic brake bleeder



- For bleeding car and LCV brakes and HGV clutches.
  - Pressure adjustment from 0.5 to 3 bar.
  - Pressure adjustment keys: up and down.
  - Electronic pressure control holds pressure steady at the selected value.
  - ABS compatible.
  - Portable, stand-alone appliance (12 V).
  - Reservoir with visible level.
  - Automatically stops below minimum level.
  - Capacity: 5 L.
  - Body: stainless/ABS.
  - Length of hose and power cable: 4 m.
  - Contains:
    - 1 multi diameter plug for using the bleeder on vehicles with a bayonet plug (DF.20-12).
    - 1 standard screw plug.
    - 1 fluid collector with attaching chain.
- Weight: 10.900 kg.

## DF.20-12A Universal plug for bleeding brakes and clutches of LCV's and HGV's



- Can be used for bleeding the brakes and clutches of 90% vehicles (incl. Asian makes, except Honda).
  - Can also be used for bleeding HGV clutches.
  - Claw system overcomes the many different bayonet shapes and different types and diameters of screw heads used by the various vehicle manufacturers.
  - Working diameter: 35 to 83 mm.
  - Minimum clearance required above the jar: 80 mm.
  - Maximum working pressure of the bleeder: 3 bar.
  - Connection by Rectus series 21 male coupling.
  - 90° swivel connection.
  - Dimensions (L. x W. x H.): 115 x 195x 85 mm.
- Weight: 475 g.

## DF.20-07 Aluminium brake bleeder plug



- Special thread fits diameter 44 and 45 mm.
  - 90° swivel connection.
  - Minimum clearance required above the jar: 40 mm.
  - Used with DF.20 - DF.21 to automatically replenish the brake fluid jar.
- Weight: 70 g.

## SPECIFIC BRAKE BLEEDING ADAPTERS

Adapters specific to certain makes (Honda, Hyundai, Mazda, Toyota, etc.) are available upon request, contact your local dealer for more details.





Disc brakes

DF.17

PNEUMATIC DISC BRAKE PISTON PUSHING/TURNING TOOLS

**Essential for replacing brake pads.**

**Quick and easy to use**

The pneumatic cylinder holds the flange against the head of the brake piston and the long handle allows the piston to be wound-back in a clockwise or anti-clockwise direction with minimum effort.

**Saves time**

The special Facom flange design covers the entire European vehicle fleet with only 9 flange types, minimising the number of flange changes and saving time.



DF.17-100 Brake disc caliper kit



- Comprising:
    - 1 DF.17 air tool.
    - 6 flanges DF.6-2 / DF.6-3 / DF.6-4 / DF.6-5 / DF.6-8 / DF.6-9.
  - Covers the majority of the European fleet.
  - Supplied in a plastic case with operating instructions and application guide.
- Poids: 2,830 kg.

DF.17 Brake disc caliper tool



- Pneumatic cylinder for retracting and rotating the piston.
- Frequency of use: at each brake pad replacement.
- Compatible with flanges DF.6A.
- Can be used on clockwise and anti-clockwise pistons.
- Max pressure: 6.2 bars 1/4 NPT, Diameter 10 mm 3/8".
- Supplied in a plastic case with operating instructions and application guide.

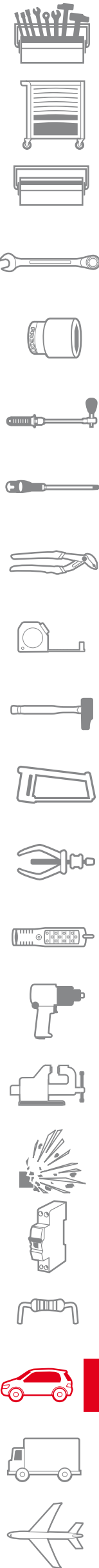

## MOD.DFD Brake disc module



- Including:
  - 31.14X15 - 31.16X17: Extra-slim open end wrenches for removing the locknuts on the caliper yokes.
  - 467F.12 - 467F.13 - 467F.14: Hinged combination wrench ratchets for removing the caliper yokes.
  - NJ.260: Impact screwdriver + bit holder sockets.
  - NJ.236A: 3/8" bit holder impact socket.
  - 83SH.7: Spherical head male key 7 mm.
  - 249.G4: Sheathed drift punch, diam. 4 mm.
  - Bits: Torx® ENX.230 - ENX.240, Phillips® N° 2 and 6-point ENH.205 5 mm.
- Thermoformed module.

## DF.3 Wire brush



- For cleaning calipers.
- Dimensions (L. x W. x H.): 225 x 45 x 15 mm.
- Weight: 65 g.

## Drum brakes

### DF.2 "SPRING HOLDER" HOOKS

#### SAVE TIME

The DF.2 "spring holder" hooks allow to save precious time when refitting drum brake shoes by freeing one of your hands.



## DF.2 Hand-brake pliers

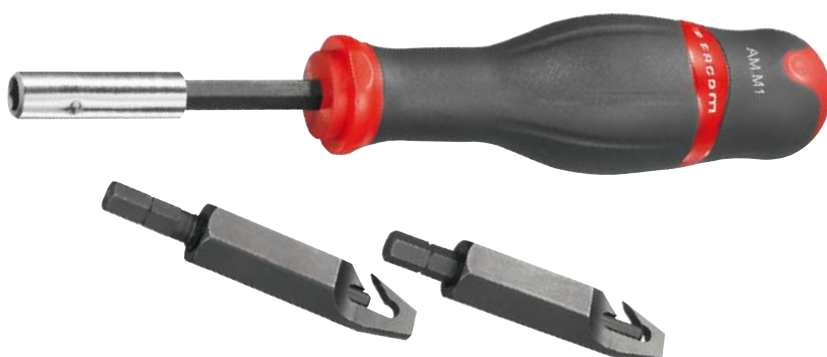

- For holding the handbrake cable spring.
- For easy hook-up of hand-brake cable with both hands.
- Set of 2 "spring stop" ends, dim.(L. x W.): 70 x 10 mm.
- 1 magnetic bit holder ref AM.M1.
- Weight: 40 g (per bit).

## 196 Brake-spring pliers

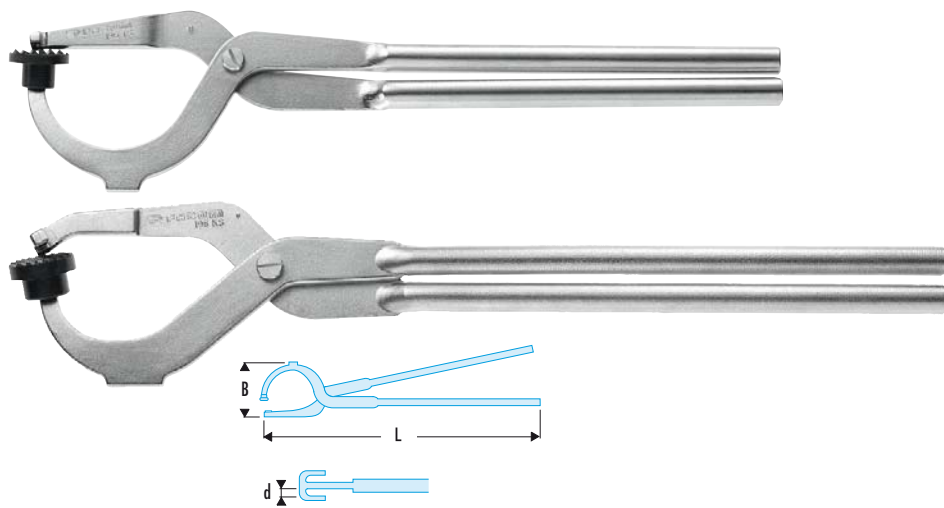

- For removing shoe springs.
- Suitable for right-handed and left-handed working.

	B [mm]	d [mm]	L [mm]	l [mm]	ΔΔ [kg]
<b>196.TS</b>	83	3	350	350	0,580
<b>196.KS</b>	100	5	485	485	1,230

## D.79A Hand-brake pliers



- For easy hook-up of hand-brake cable.
- Length: 230 mm.
- Weight: 180 g.

## D.104B Steady-spring tool



- Fits steady-spring caps for compression against drum-brake shoes.
- Adapts to all makes.
- Length: 240 mm.
- Diameter: 34 mm.
- Weight: 240 g.

## MOD.DFT Drum brake servicing module



- Including:
  - D.104A: Steady-spring tool.
  - DF.2: Hand-brake cable screwdriver.
  - D.79A: Hand-brake pliers.
  - 43.8x10 - 43.11x13: Flare-nut wrenches.
  - Tray PL684.
- Weight: 855 g.

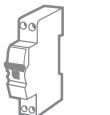
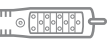
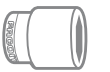



## Brake lines

### BRAKE LINE RENEWAL

#### REFORM FLANGES AS NEW

#### A complete set of brake line renewal tools.

Press 347 can be used to form all types of SAE or DIN flanges on the workbench. It is particularly suitable for LCVs and HGVs.

The DF.475 hand press can be used directly on light vehicles to reform flanges, without the need to remove the entire pipe.



#### DF.475A Flange press



- Specifically designed for flanging (diam. 4.75 mm) automotive brake lines.
- SAE or DIN fittings are formed easily with the help of its 3 T hydraulic jack.
- Compact size allows working in situ on vehicles.
- Diameter: 4.75 mm.
- Dimensions (L. x W. x H.): 212 x 200 x 75 mm.
- Weight: 1.100 kg.

#### 347 Flange press set for S.A.E., DIN, S.A.E./DIN fittings



- Capacity: for copper and steel pipework diameter 4.75 to 12 mm; 3/16" to 1/2".
- Wall thickness: 0.7 to 1 mm.
- Press can be secured in a vice for increased stability.
- Fast and effortless forming.
- Kit includes 11 punches and 10 dies. Instructions explain selection according to flange type.
- Steel case.
- Dimensions (L. x W. x H.): 396 x 224 x 82 mm.
- Weight: 7.900 kg.

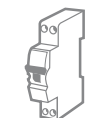
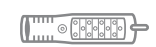



# DLS.500HP

# SUSPENSION

## SPRING COMPRESSORS

### Safety and efficiency

DLS.500HP offers the highest productivity.

- Easy and fast changing of struts to adapt to the vehicle concerned.
- Effortless pneumatic compression.
  
- While guaranteeing optimum safety. By full application of the European Directive on Machinery 2006 42/CE.

### SPRINGS = DANGER

Compression of springs, increasingly strong and complex-shaped remains a frequent source of occupational accidents in workshops.

### 4 safety benefits

- Strut strength tested at 1.5 times the max pressure of the machine.
- Protection barrier closing mandatory, checked by an air intake cut-off valve preventing use in open position.
- Compression speed regulated at less than 10 cm /second.
- Check valves preventing clamps from opening in case of accidental air supply cut.

**DLS.500HP = MAXIMUM SAFETY**





**■ DLS.500HP Pneumatic spring compressor**



- Pneumatic spring compressor for removing and fitting shock absorbers on Mac Pherson struts.
- Pressure: 1200 to 2200 kg according to air pressure (7 to 10 bars).
- Compression travel: 440 mm.
- Triple safety device:
  - Protection barrier with automatic air stop device.
  - Regulated compression speed.
  - Protection valve preventing jaw opening in case of accidental air cut off.
- Supplied with 2 flanges (springs 78 to 220 mm).
- Dimensions: 590 x 590 x 1530 mm.
- Weight: 66 kg.

**■ DLS.500-04 Special forks for Asian vehicles**



Weight: 970 g.

**■ DLS.500-05 Special upper fork for Mercedes prior to 2010**



Weight: 4.510 kg.

**■ DLS.500-06 Vice for lower grip on Mc Pherson strut**



- For long and regular springs.
- Weight: 3.966 kg.

**■ DLS.500-07 Lower fork for Renault - Nissan**



- For Renault Koleos / Nissan Qashquai, reversed pitch springs.
- Weight: 4.400 kg.

**■ DLS.500-08 Lower fork diameter 105 to 182 mm**



- Example of use: Citroen C3, Peugeot 206 / 207, Renault mégane III, Ford Fiesta, VW Golf VI.
- Weight: 4.430 kg.

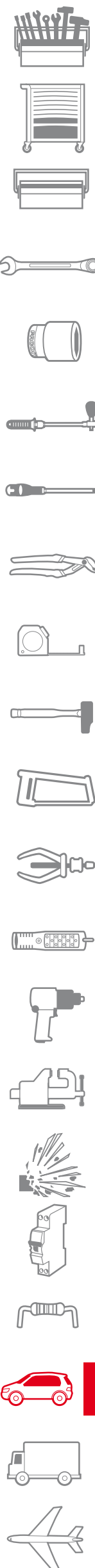

## U.89 SPRING COMPRESSOR - AN UPGRADEABLE INVESTMENT

### The most universal system

Whether used on a workbench or workstation, this tool evolves according to your needs through its range of accessories available.

- Since it was set up in 1995, our database lists all vehicles U.89 adapts to.
- Each unit is supplied with a list of allocations and updates are available on [www.facom.com](http://www.facom.com).



### U.89M20 Mini mechanical set



- Kit includes
    - U.89M: Mechanical body.
    - U.89J1: Set of forks.
    - U.89J2: Set of forks.
  - Supplied with operating instructions and vehicle application guide.
- Weight: 14,700 kg.



## U.89M30 Standard mechanical set



- Kit includes
- U.89M: Mechanical body.
- U.89J1: Set of forks.
- U.89J2: Set of forks.
- U.89J3: Set of forks.
- Supplied with operating instructions and vehicle application guide.
- Weight: 19.100 kg.

## U.89M Mechanical body



- Two-stage screw operated telescopic body.
- Hexagonal drive: 22 mm.
- Can be used with an electric or mechanical impact wrench.
- Tested to 100,000 N.
- Fitted with a safety pin.
- Can be used with all U.89 forks.
- Travel: 235 mm.
- Extended length: 540 mm.
- Compressed length: 305 mm.
- Diameter: 70 mm.
- Weight: 5 kg.

## U.89M2JM Mechanical compressor with multi-diameter fork set



- Kit includes
- U.89M2: Mechanical body with two-position spacer.
- U.89JMA: Pair of multi-diameter forks for spring diam. 100 to 215 mm.
- Supplied with operating instructions and vehicle application guide.
- Weight: 11.600 kg.

## U.89M230 Spring compressor - Universal system with interchangeable forks



- Two-stage screw operated telescopic body (hexagonal up to 22 mm).
- Mobile spacer for two possible working positions for the forks.
- Drive possible by 1/2 inch impact wrench.
- Body tested to 100,000 N.
- Travel: 235 mm.
- Compressed length: 305 mm.
- Extended length: 540 mm.
- Diameter: 70 mm.
- Supplied with 3 sets of plastic-coated forks J1 - J2 - J3.
- CE.
- Weight: 14.700 kg.

## U.89M2 Mechanical body



- Two-stage screw operated telescopic body.
- Hexagonal drive size 22 mm. Can be used with 1/2 inch electric or pneumatic impact wrench.
- Tested to 100,000 N.
- Spacer allowing to place the lower fork in two positions: allows for maximum travel on springs with few coils.
- Can be fitted with all U.89 forks.
- Travel: 235 mm.
- Compressed length: 305 mm.
- Extended length: 540 mm.
- Diameter: 70 mm.
- Weight: 5.100 kg.

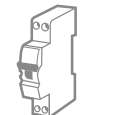
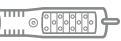
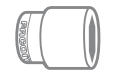



## U.89JMA Multi-diameter fork set



- Offset forks: grip the spring at the end of the coil, this increasing the compressor's effective travel. This shape of fork is particularly effective for use on new-generation springs having a small number of coils.
  - A hinged joint at the connection to the compressor allows the fork to be aligned with the slope of the coil.
  - New design, fork fits directly onto the springs for quick installation.
  - Suitable for 100 to 215 mm springs.
  - Compatible with all U.89 bodies without modification.
- Weight: 6.600 kg.

## Workstation

### SUSPENSION - WORKSTATION

Upgrade your U.89 spring compressor.



+



=



## DLS.400 Spring compressor workstation (naked)



- Designed to receive FACOM compressor ref U.89M2 - U.89H2.
  - Can accommodate up to 6 sets of forks.
  - Impact wrench storage space.
  - Space for set D.83C (new XL module).
  - Space for application list.
  - Hook for torque wrench.
  - Small plan dimensions: 590 x 590 mm.
  - Closed height 1.430 max height: 1.726 mm.
  - Supplied with operating instructions and vehicle application guide.
- Weight: 39.385 kg.

## ■ DLS.300-03 Compressor holder



- For attaching a compressor type U.89M or U.89H to workstation DLS.300.
  - For bodies of max. diameter: 55 mm.
- Weight: 700 g.

## ■ D.22B Special workbench vice



- For holding struts vertically on the workbench.
  - Max diameter: 65 mm.
  - Dimensions (L. x W.): 410 x 190 mm.
  - Finish: zinc.
- Weight: 3.535 kg.

## Strut removal

### ■ DS.J5 Mac Pherson clamp separator set



- Including:
  - DS.10A: 7.5 x 9 mm.
  - DS.11A: 5.2 x 6.9 mm.
  - DS.12A: 6.6 x 7.9 mm.
  - DS.13: 4.3 x 6.0 mm.
  - DS.14: 12.7 x 16.7 mm.
  - DS.P: 3/8" (9.53 mm) square drive operating handle.
  - J.236: Bit holder socket.
- Helps open the clamp on vehicles fitted with Mac Pherson struts.
- Allows shock-absorbers to be stripped down at the work bench.
- Fast and efficient.
- All vehicles fitted with removable clamps (Citroen, Peugeot, Ford, VAG, Audi).
- A "junior" series ratchet can be used instead of the handle (space provided in the case).

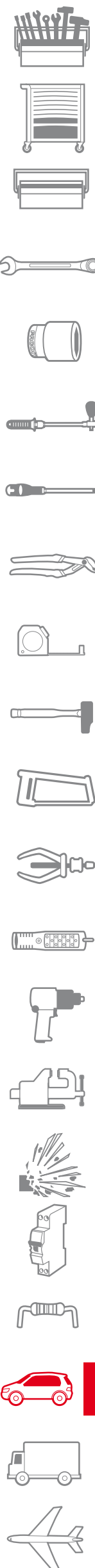



### Tools for shock absorbers

#### ▣ D.83C Set of 28 tools in modules for Mac Pherson strut rods

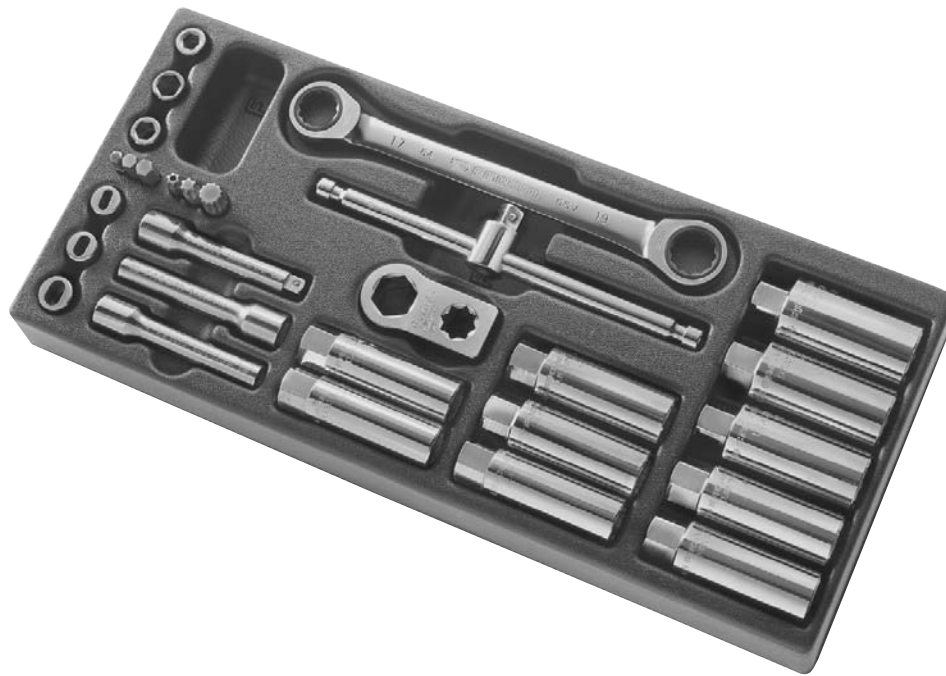

- Including:
  - 10 long-reach sockets 14 - 15 - 16 - 17 - 18 - 19 - 21 - 22 - 24 mm.
  - Slotted bits (3 No.) 5, 6 and 8 mm.
  - 6-point sockets (3 No.) 8, 9 and 11 mm.
  - 1 magnetic bit holder extension 7.94 mm.
  - 1 bit-holder extension 6.35 mm.
  - 1 extension with square drive 8 mm.
  - EH bits: 6 - 7 - 8 mm .
  - Bits: EXR.140 - EX.245 - XZN EV.212.
  - 1 handle: J.120.
  - 1 wrench 68: 17x19.
  - 1 torque wrench adaptor.
- For holding the strut rod while tightening or loosening of the nut, for tightening with a torque wrench to a specified torque.
- Tool can be extended to include other bits (Torx, XZN, 6-point).
- XL module.
- Tray PL.647.
- Supplied in modules for placing in the drawer of a roller cabinet or workbench. Empty spaces for additional tools.

#### ▣ D.84 Set of lug adaptors for VAG struts

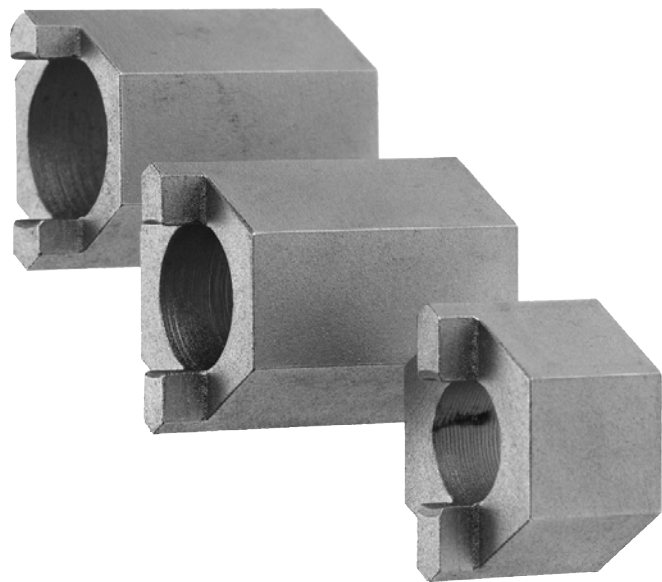

- For loosening and tightening notched nuts on strut rods.
    - AUDI: 80 / 90.
    - SEAT: Terra / Ibiza / Marbella / Toledo / Cordoba.
    - VOLKSWAGEN: Polo / Golf / Jetta / Passat / Vento
- Weight: 70 g.



## Wheel removal and inspection

### MOD.208 Wheel nut tightening module



- 77AT0D: Cross brace.
  - S.208 - 200: Torque wrench 40 to 200 Nm.
  - NSB.17 - 19 - 21: Long-reach impact sockets.
  - SH.17 - 19 - 21: 6-point sockets.
  - Tray PL.337.
- Weight: 5.470 kg.

### Cross braces



- Designed for removing wheel nuts on cars, light commercial and heavy goods vehicles.
- Replaceable bit on wrenches featuring a square drive.
- 77.P1: Spare male 3/4" square bit.
- 77.T1: Spare male 1/2" square bit.

FACOM	d [mm]	L [mm]	l [mm]	Square ["]	ΔΔ [kg]
<b>77A.TO</b>	17 - 19 - 23	400	400	1/2	1,750
<b>77A.T02</b>	17 - 19 - 23	400	400	1/2	1,750
<b>77A.T0D</b>	17 - 19 - 23	400	400	1/2	1,750
<b>77A.PL1</b>	24 - 27 - 30 - 32	700	700	-	4,650
<b>77A.PL2</b>	24 - 27 - 33	700	700	3/4	4,580
<b>77A.PL2D</b>	24 - 27 - 32	700	700	3/4	4,600

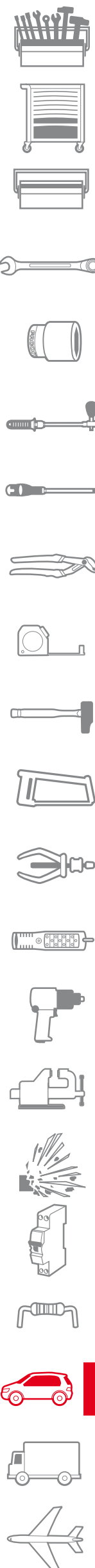

## U.179A Air-line connector and gauge



- Pressure range: 0 to 12 bar.
- Impact-resistant rubber casing.
- Dimensions (L. x W. x H.): 250 x 120 x 80 mm.
- Weight: 850 g.

## 1/2" composite impact wrench

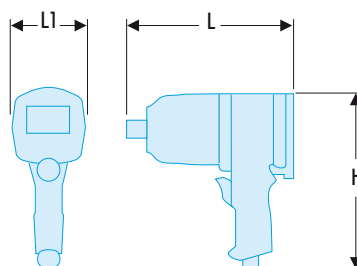

- Structure: composite.
- Impact system: double hammer.
- Maximum torque: 1080 Nm.
- Soft control trigger.
- Power setting: 3.

FACOM	L [mm]	L1 [mm]	H [mm]	ΔΔ [kg]
<b>NS.1800F2</b>	180	69	183	2,200

## NSAL.3 Set of long-reach thin wall sockets for alloy wheels



- Including:
  - 3 impact sockets: 17 - 19 - 21 mm.
- Plastic coated to protect varnished alloys against impact damage.
- The 3 sizes are immediately identifiable.
- Supplied with a set of additional plastic protective sleeves (red, blue, yellow).
- Weight: 775 g.

## N.709 Air-hose reel



- Polyurethane hose, inner diam. 10 mm.
- Specifically designed for high air consuming tools (impact wrenches).
- Very high strength, return spring tested to 20,000 cycles minimum.
- Length: 15 m + 1.
- Hose stop every 50 cm.
- Pressure: 15 bar.
- Weight: 6.800 kg.

### ▣ D.93 Valve core remover



- The swivelling head and fluted body derived from the Facom Microtech screwdriver simplifies valve core removal and fitting.
- Length: 102 mm.
- Weight: 15 g.

### ▣ D.3 - Tyre-remover



- Double tee section for added strength.
- Finish: zinc and chrome-plated.

▣	l [mm]	ΔΔ [g]
<b>D.3-300</b>	300	200
<b>D.3-400</b>	400	400
<b>D.3-500</b>	500	570
<b>D.3-600</b>	600	900

### ▣ U.16 - Ball joint pullers



- Used to dismount steering and suspension ball joints.
- Supplied with a set of 2 spare safety pins.
- U.16-05J3: Set of 3 pins for U.16B and U.16A18.
- U.16-A45-05J3: Set of 3 shear pins for U.16B32 and U.16B45.

▣	A [mm]	d [mm]	l [mm]	ΔΔ [kg]
<b>U.16A18</b>	45	16	100	0,635
<b>U.16B</b>	45	22	100	0,665
<b>U.16B32</b>	80	32	158	2,452
<b>U.16A45</b>	80	45	158	2,543

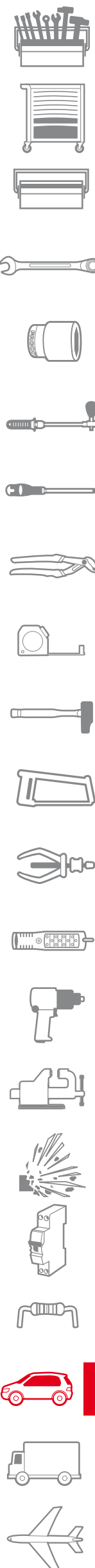



## ▣ D.138 Lower ball-joint socket



- Castle nut socket.
- 6-point drive: 32 mm.
- Tightening torque: 250 N.m.
- For models:
  - CITROEN: BX / Xsara / XM / Xantia.
  - PEUGEOT: 306 / 309 / 405 / 406.
- Dimensions (L. x W.): 52 x 48 mm.
- Weight: 230 g.

## U.7 - STEERING BALL JOINT REMOVAL AND FITTING TOOL

### Easier maintenance

### Saves time

To fit and remove steering ball joints without having to remove the rack. Access by the fender flange.

### Powerful

6-point 30 mm drive square for powerful tightening or unlocking torque (e.g. 200 Nm on Golf VI).

### Easy maintenance

Removable cage for easy cleaning and servicing of the tool.



## ▣ U.7 Axial ball-joint unlocking tool



- Used to dismount steering ball joints from 35 to 45 mm.
- The head is made of a cage with three treated steel rollers. Rotating the tool locks the rollers between the body and the ball-joint to screw or unscrew.
- Treated steel rollers, nylon cage.
- 6-point drive: 30 mm for more power.
- Tube length: 420 mm.
- Head diameter: 82 mm.
- Weight: 1.750 kg.

▣ **D.143B** Socket for angular tightening of the hub nut



- Drive bit: 3/4".
- 6-point drive 36 mm.
- Weight: 415 g.

▣ **DM.14** Transmission collar clamp

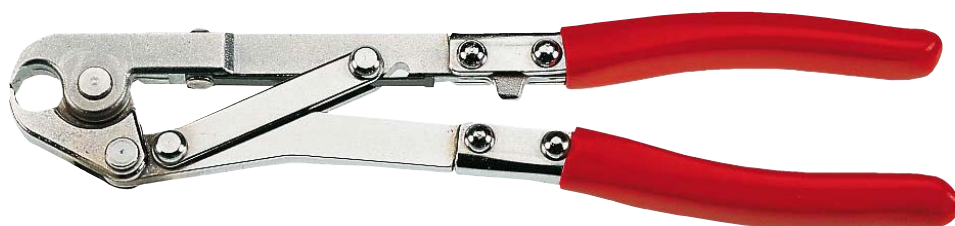

- To crimp collars on transmission bellows.
- For OETIKER collar.
- Dimensions (L. x W. x H.): 280 x 50 x 20 mm.
- Weight: 475 g.

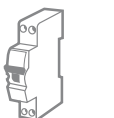
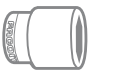
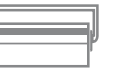

# AUTOMOTIVE BODYWORK

## TIME-SAVING TOOLS AT EVERY STAGE



**Stripping, cutting, forming, assembling, painting, windshields, pneumatics.**

In order to improve your everyday working life, Facom offers customised solutions for :

- Saving time.
- Optimising storage.

### Workstations



### Supports





**BODYWORK COMPONENT STORAGE STAND**

**Reduce operator movements,  
Optimise your storage.**

For storing bonnets, tailgates, wheels, etc.

- Guarantees efficient organisation.
- Optimise workshop movements.
- Investment recovered in 3 months.



**CR.S1 Bodywork component storage stand**



- Maximum supported weight 150 kg.
- For storing bonnets, doors and exhaust systems.
- Incorporates anti-slide stops & gravity stabiliser.
- Dimensions: 90 x 60 x 190 cm.
- 4 castor wheels.
- Dimensions (L. x W. x H.): 90 x 60 x 190 cm.
- Weight: 41 kg.

**CR.S11 Mechanical component storage stand**



- Storage of removed components on 4 levels for easy identification of the order of reassembly.
- 4 castor wheels for east manoeuvring around the vehicle.
- 2 fluid storage containers (water, oil) for a clean workshop.
- 2 plastic bins for fasteners.
- Dimensions (L. x W. x H.): 165 x 90 x 60.5 cm.
- Weight: 40 kg.

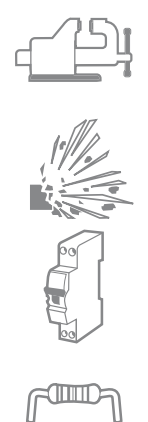
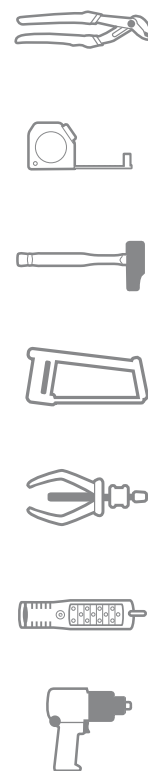
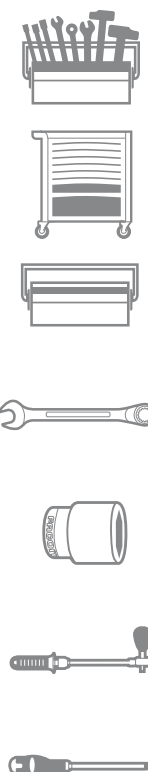

## CR.S5 - DOOR INSTALLATION AND REMOVAL

### Saloons, light commercial vehicles and 4x4s

#### Versatile

- Suitable for positioning any type of door.
- Fully adjustable. Work with or without glazing.

#### Precise

- Progressive electric motor control providing millimeter precision.
- 4 castor wheels, 2 with brakes for total manoeuvrability.

#### Practical

- Motor fitted with a remote control, allowing the door to be guided while raising or lowering the support.
- Compact design for easy storage.
- Foam-covered supports to protect paintwork.

#### Safe

- Easy access to fuse for added safety.
- Supports 150 kg.



#### INFORMATION

Door installation and removal sometimes involves carrying heavy loads. The electric stand avoids this and allows you to comply with labour legislation that advocates the reduction of physical effort, especially that liable to cause back injury.

The electric stand will help improve working conditions in your workshop while enabling one person to work on the doors on their own.



**1 operator**  
**Reduced effort.**  
**Maximum accuracy.**

### CR.S5 Electric door removal and installation stand



- Maximum supported weight 150 kg.
- Suitable for saloons and 4x4 (using CR.S5UTL).
- Works with or without glazing.
- Millimeter precision.
- Small footprint (52 x 90 cm).
- 4 castor wheels (2 with brake).
- Holders with rubber anti-scratch protections.
- 220 V mains powered electric motor with easy-to-reach fuse.
- Dimensions (L. x W. x H.): 52 x 90 x 120.5 cm.
- Weight: 27 kg.

- Accessory for lateral slide door: CR.S5UTL.



**CR.S6** Heavy-duty support stand for engines, gearboxes, etc.



- Maximum supported weight 450 kg.
  - Modular support: many applications in bodywork and mechanical workshops.
  - Raised stand (CR.S9) transforms the tool into a waist-height work table.
  - Allows high pressure jetting before reassembly.
  - Sliding, removable containers allow recovery of liquids.
  - Dimensions (L. x W. x H.): 90 x 80 x 40 cm.
- Weight: 27 kg.

**CR.S9** Raised stand for CR.S6



- Maximum supported weight 450 kg.
  - Raised stand transforms support (CR.S6) into a waist-height work table.
  - Allows high pressure jetting before reassembly.
  - Transforms into a work table with raised stand CR.S9.
  - Dimensions (L. x W. x H.): 90 x 80 x 80 cm.
- Weight: 15.500 kg.

**CR.S8** Support for moving vehicles with no steering gear



- Maximum supported weight by CR.S8: 450 kg.
  - To support and move vehicles without front axle.
  - Width adjustment (110 to 160) to suit vehicle.
  - 4 castor wheels.
  - Axle supported on a rubber-coated pivoting saddle.
  - Dimensions (L. x W. x H.): (110 to 160) x 50 x 30 cm.
- Weight: 21 kg.

**CR.S12** Mobile support



- Maximum supported weight by CR.S8: 600 kg.
  - For supporting 1/2 front or rear axles having suffered a locked wheel or a flat tyre.
  - 4 castor wheels.
  - Dimensions (L. x W. x H.): 58 x 37 x 17 cm.
- Weight: 10 kg.

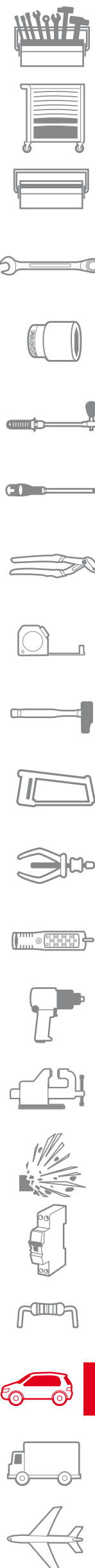



## Stripping tools

### ▣ CR.D1 Trim clip removal plier



- For quickly removing staples, clips, door panels, facia and trim supports, etc.
  - Wide nose for undoing facings without risk of breaking or tearing panels.
  - Finger guard to avoid injury.
  - Designed for accessing difficult-to-reach places.
  - Length: 240 mm.
  - Finish: black head, chrome pliers.
- Weight: 190 g.

### ▣ D.115A Trim removal tool



- For removing interior door trimmings without damage.
  - Dimensions (L. x W. x H.): 155 x 32 x 45 mm.
- Weight: 106 g.

### ▣ D.137A Fastener removal tool



- For removing plastic fasteners securing carpets, trim and panels.
  - Capacity:
    - Fitter diameter: 9 to 22 mm springs.
    - Body diameter: 4 to 9 mm springs.
  - Dimensions (L. x W. x H.): 200 x 28 x 40 mm.
- Weight: 110 g.

### ▣ RSX.19A Set of 1/4" and 1/2" drive sockets and Torx driver bits



- Tray PL.393A.
  - Plastic case BP.102.
  - Dimensions (L. x W. x H.): 204 x 122 x 52 mm.
- Weight: 620 g.

### ▣ CR.D5 Plastic component removal tool set



- For removing or unclipping plastic components (dashboard, door, external trim, snap rings, etc.).
  - Set of 5 tools for different applications.
  - Supplied in blister pack.
- Weight: 275 g.

PLASTIC MULTIFUNCTION TOOLS

**Practical**

To remove plastic parts inside or outside the vehicle.

**Safe**

They protect plastic or varnished parts, trim, ceramics, etc.



■ **CR.D4** 4-piece set of plastic multi-use tools



- For removing adhesive weights from wheels in alloy, silicon, elastic sealing products, hub caps, etc.
  - No damage to plastic or varnished parts, trim, ceramics, etc.
  - 4 widths: 19 - 22 - 25 - 38 mm.
  - For use with a hammer and resharpenable with a file.
  - Supplied in blister pack.
- Weight: 525 g.

Power tools

■ **E.2005** Heat gun



- Electronic temperature control 60 to 600°C.
  - Force: 2000 W.
  - Power supply: 220 V/50 Hz.
  - Air flow rate (2 speeds): 300 l/min and 500 l/min.
  - VDE approved.
  - Supplied with 2 nozzles: E.2002B1 - E.2002B3.
  - Dimensions (L. x W. x H.): 330 x 80 x 72 mm.
- Weight: 770 g.
- Distribution nozzle, dim. (L. x h x d): 75 x 75 x 33.7 mm; weight 58 g: E.2002B1.
  - Cross-flow nozzle, dim. (L. x h x d): 75 x 80 x 33.7 mm; weight 56 g: E.2002B2.
  - Reflector nozzle, dim. (L. x h x d): 33 x 60 x 33.7 mm; weight 32 g: E.2002B3.
  - Concentrator nozzle, dim. (L. x h x d): 20 x 52 x 33.7 mm; weight 30 g: E.2002B4.

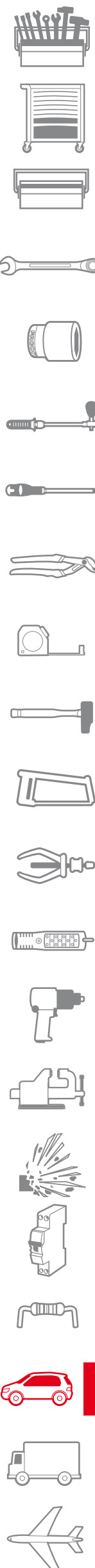

## Cutting - drilling

### Chisels

#### ▣ 231 Three-square scraper



- Finish: high quality steel blade, polished chrome finish and varnished wood handle.
- Shank length: 200 mm.
- Weight: 180 g.

#### ▣ 259 Slim-profile chisels

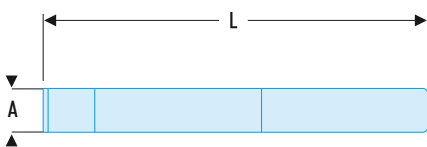

- Slim profile chisel.
- Chrome vanadium forged steel, treated 57 HRc on edge and 40 HRc on impact head.
- Blade width: 26 mm.
- Length: 235 mm.
- Presentation: lacquered.
- Weight: 240 g.

#### ▣ 259.P Slim-profile chisel with guard

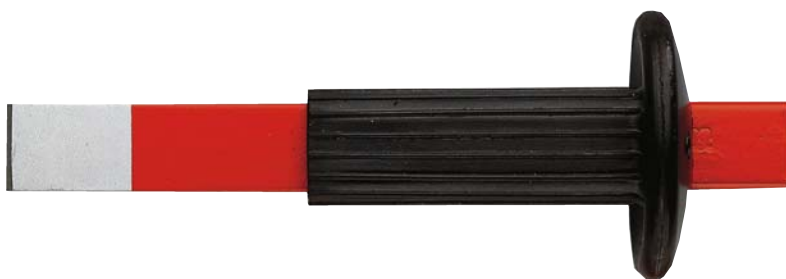

- Chisel with guard, diameter: 85 mm.
- Chrome vanadium forged steel, treated 57 HRc on edge and 40 HRc on impact head.
- Blade width: 26 mm.
- Length: 235 mm.
- Presentation: lacquered.
- Weight: 400 g.

#### ▣ 260.P Wide chisel with guard



- Chisel with guard, diameter: 85 mm.
- Chrome vanadium forged steel and hardened to 57 HRc on edge.
- Edge resharpening with grinder.
- Head hardened to prevent head effect.
- Blade width: 60 mm.
- Length: 250 mm.
- Presentation: lacquered.
- Weight: 630 g.



Drill bits

229A - Boring bits

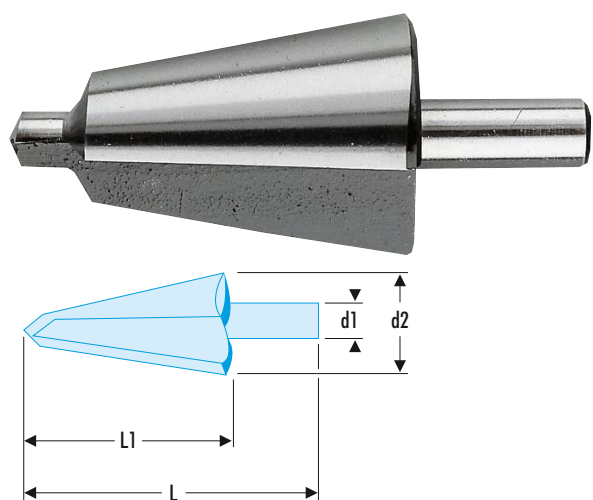

- For drilling, deburring, boring thin materials: press sheet, non ferrous metals.
- HSS steel.
- Max. thickness recommended: 4 mm.
- Does not require a tapping hole.

Code	d1 [mm]	d2 [mm]	L [mm]	L1 [mm]	l [mm]	ΔΔ [g]
229A.1	6	3 - 14	59	37	59	25
229A.2	8	5 - 20	71	41	71	45
229A.3	9	16,0 - 30,5	76	48	76	130

229A.J3 Set of 3 tapered bits



- Capacity: 3 to 30.5 mm.
- Supplied with a bottle of lubricant.
- Supplied in a pressed sheet box, dim. (L. x W. x H.): 120 x 100 x 38 mm.
- Weight: 555 g.

229A - Stepped bits

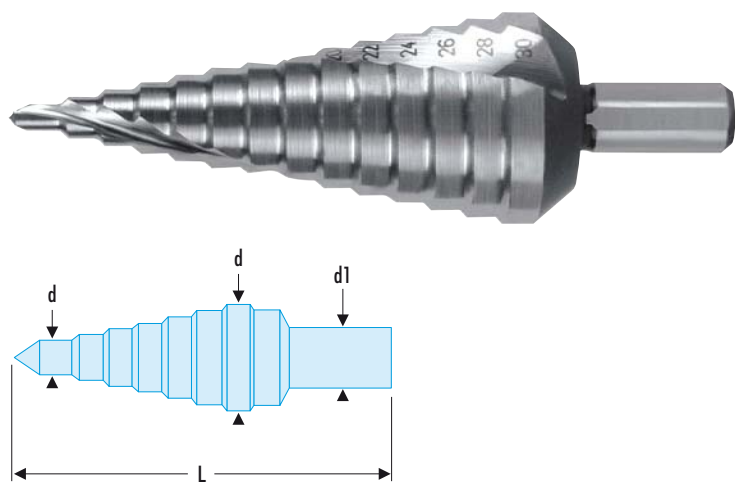

- For cylindrical high accuracy drilling in all materials.
- HSS steel.
- Cylindrical shank with 3 flats for proper drive, avoiding micro locking.
- Laser marking of different diameters in a groove.

Code	d1 [mm]	d mini - maxi [mm]	L [mm]	l [mm]	ΔΔ [g]
229A.ST0	6	4 - 5 - 6 - 7 - 8 - 9 - 10 - 11 - 12	65	65	25
229A.ST1	8	4 - 6 - 8 - 10 - 12 - 14 - 16 - 18 - 20	75	75	65
229A.ST2	10	4 - 6 - 9 - 12 - 15 - 18 - 21 - 24 - 27 - 30 - 33 - 36 - 39	107	107	315
229A.ST3	10	6 - 9 - 13 - 16 - 19 - 21 - 23 - 26 - 29 - 32 - 35 - 38	100	100	320

VFA - Filing burrs



- Tungsten carbide mill.
- Right-hand cut.

Code	No.	d [mm]	L [mm]	tr/min	ΔΔ [g]
VFA.600	1	6	18	50000	25
VFA.602	2	6	18	50000	25
VFA.604	3	6	18	50000	25
VFA.606	4	6	18	50000	20
VFA.608	5	6	18	50000	20
VFA.610	6	6	15	50000	20
VFA.1200	1	12	25	20000	55
VFA.1202	2	12	25	20000	55
VFA.1204	3	12	25	20000	50
VFA.1206	4	12	25	20000	30
VFA.1208	5	12	25	20000	35
VFA.1210	6	12	20	20000	40

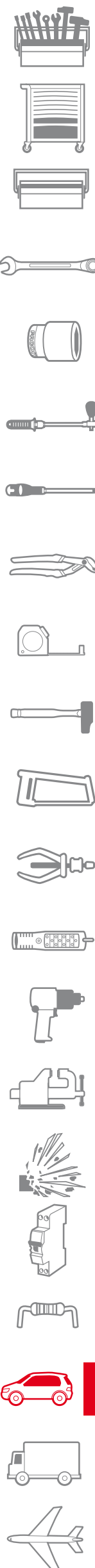

## End mills



- Super fast HSS steel self-centring and resharpenable drill bits.
- Available in sets of 2 identical diameter bits (J2) or 3 different diameter bits (J3).

	d [mm]	l [mm]	ΔΔ [g]
<b>225.6J2</b>	6	66	36
<b>225.8J2</b>	8	77	50
<b>225.10J2</b>	10	88	90
<b>225.J3</b>	6 - 8 - 10	-	90

## 230 Welding spot mill



- This tool, fitted on a drill, separates two spot-welded metal sheets.
- Includes the mill holder assembly, reversible mill and centring tip.
- Not compatible with ref V.781B.
- Length: 70 mm.
- Weight: 23 g.
- Set of 5 spare tips: 230.A1J5.

## 230.J1 Set of mills



- Set with a 230 module, 2 centring tips and 10 reversible mills.
- Dimensions (L. x W. x H.): 115 x 65 x 22 mm.
- Weight: 90 g.
- Set of 5 spare tips: ref 230.A1J5.

Miscellaneous

▣ 270A.MA Steel wire brush



- Dimensions (L. x W. x H.): 280 x 34 x 60 mm.
- Weight: 150 g.

▣ 245.J1 "Standard" kit

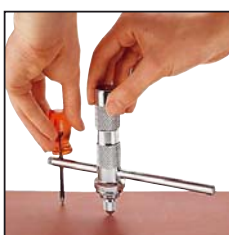

- For making round gaskets.
- Cutting capacity: diam. 3 to 30 mm using a punch and diam. 56 to 330 mm using calipers.
- Plastic case BP.115.
- Tray PL.100A.
- Dimensions (L. x W. x H.): 332 x 143 x 67 mm.
- Weight: 1.800 kg.

▣ 235.J1 Set of 3 stainless steel scrapers



- Dimensions:
- Length: 215 mm.
- Width: 32 mm straight - 32 mm angled - 50 mm straight.
- Weight: 427 g.

▣ 237.J1 Set of 3 flexible wide scrapers



- Dimension:
- Length: 215 mm.
- Width: 32 mm - 50 mm - 75 mm.
- Weight: 273 g.

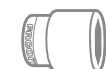



## Air hammer

### Power chisel with hexagonal shank



- Built-in power regulator.
- Impact rate 3,000 min.
- Working pressure: 6.2 bars.
- Average air consumption: 90 l/min.
- Air inlet thread: 1/4".
- Power: 0.8 kW.
- Piston stroke: 67 mm.
- Straight chisel: V.320HA1.
- Punch (hexagonal shank): V.320HA2.
- Weld point cutter (hexagonal shank): V.320HA3.
- Sheet metal cutter (hexagonal shank): V.320HA4.
- Double-edge sheet-metal cutter (hexagonal shank): V.320HA5.

FACOM	L [mm]	L1 [mm]	H [mm]	ΔΔ [kg]
<b>V.320FH</b>	171	50	160	1,580

### V.321AH Power chisel set



- Kit includes
  - V.320FH: 1 power chisel.
  - 1 sheet-metal cutter.
  - 1 double edge sheet-metal cutter.
  - 1 weld point cutter.
  - 1 straight chisel.
  - 1 punch.
- Weight: 6.300 kg.

Air tools

▣ Sabre saw

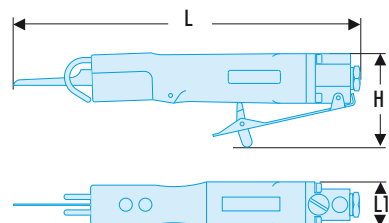

- Seamless straight and curved cutting.
- Suitable for flat and convex surfaces.
- Adjustable blade guide.
- Strokes per minute: 10,000.
- Average air consumption: 32 l/min.
- Air inlet thread: 1/4".
- Air hose int. diameter: 10 mm.
- Supplied with 3 x 10 teeth/cm blades and blades x 12 teeth/cm blades.
- Set of 6 12 teeth/cm blades: V.770F1.
- Set of 6 10 teeth/cm blades: V.770F2.

FACOM	L [mm]	L1 [mm]	H [mm]	ΔΔ [g]
V.770F	270	36	75	700

▣ V.103MF Drill 10 mm with self-locking chuck

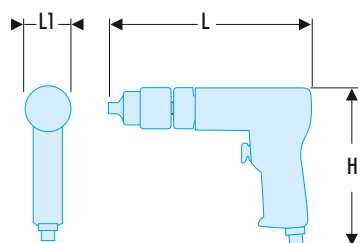

- 10 mm Quick chuck.
- Free speed: 2800 rpm.
- Average air consumption: 124 l/min.
- Air inlet thread: 1/4".
- Working pressure: 6.2 bar.
- Motor power: 0.45 kW.
- Spare chuck: V.103MFMA1.

▣ Nibbler

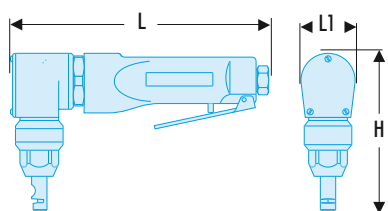
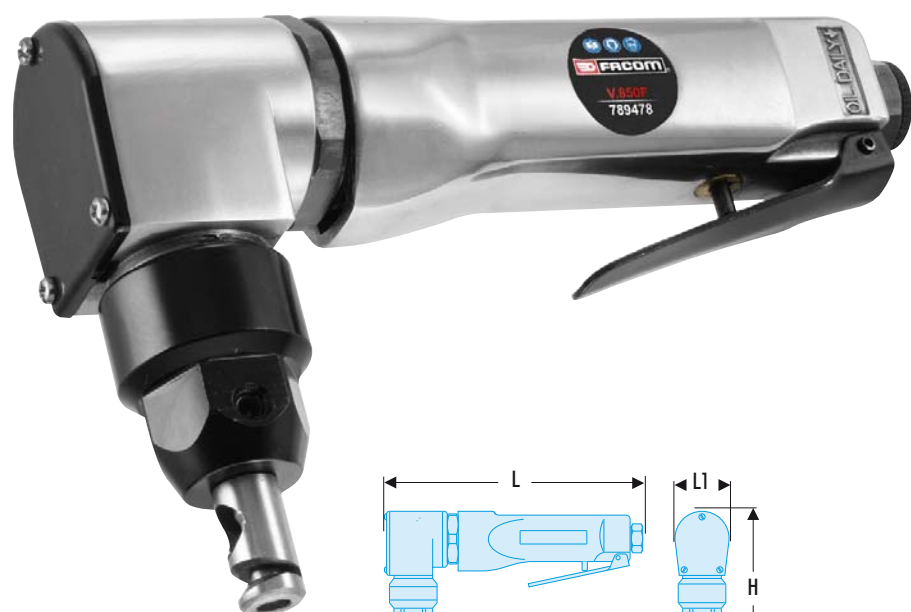

- Lever throttle for precise control and low-speed start.
- Can produce rounded edges up to 6.5 mm radius.
- Max. thickness: 1.2 mm - speed 1.8 m/min.
- Strokes per minute: 4300.
- Average air consumption: 120 l/min.
- Air inlet thread: 1/4".
- Air hose int. diameter: 10 mm.
- Punch set: V.850FKR2.

FACOM	L [mm]	L1 [mm]	H [mm]	ΔΔ [g]
V.850F	179	40,5	118	900

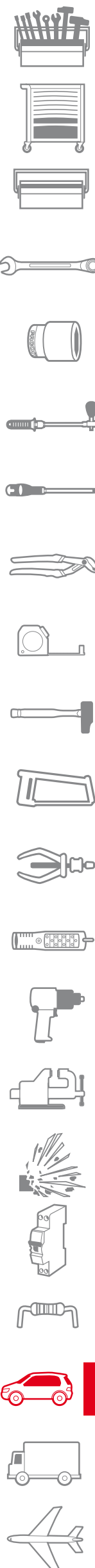

## Spot weld remover with stop

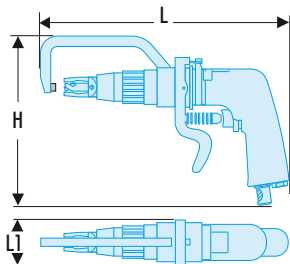

- Fitted with a counterarm to hold the workpiece in position without slipping.
- Speed control.
- Free speed: 1800 rpm.
- Average air consumption: 110 l/min.
- Air inlet thread: 1/4".
- Working pressure: 6.2 bar.
- Milling cutter diameter 8 mm.
- Milling cutter diameter 8 mm: V.781A1 (minimum order quantity: 5).

	L [mm]	L1 [mm]	H [mm]	ΔΔ [kg]
<b>V.781F</b>	270	53	198	2,100

## Angle grinder - 6 mm collet

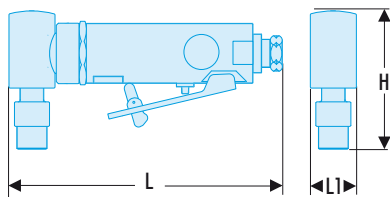

- Angle grinder for grinding wheel with shank.
- For cutting and cleaning.
- Compact motor with sturdy blades.
- Compact angled head for difficult-to-reach places.
- Exhaust air duct with integral air supply pipe.
- Air connection: female thread 1/4".
- Recommended air hose: int. diam. 8 mm.
- Recommended fitting: thread-internal diameter 1/4" - 6 mm.
- Pressure: 6.2 bar.
- Speed of rotation: 18,000 rpm.
- Average air consumption: 110 l/min.
- Noise level: 77.3 dB(A).
- Vibration level: below 2.5 m/s<sup>3</sup>.
- Power: 0.25 kW.
- Supplied with 6 mm pliers + 2 open end wrenches.

	L [mm]	L1 [mm]	H [mm]	ΔΔ [g]
<b>V.347F</b>	160	27	73	700

## AIR TOOLS



➤ Power tools section p. 676



Forming

FORMING

BODYWORK REPAIR WORKSTATION

**EFFICIENT, MORE COMFORTABLE STORAGE**

Designed to keep everything close to hand, save time and avoid losing tools.

**GALVANISED STEEL WORKTOP**

- Easy to maintain.
- High strength.



**SAFETY**

- Central key locking.
- Drawer fronts fitted with a catch to prevent accidental opening.

**CORNER BUMPERS**

- To avoid damage to vehicles in case of accidental contact

**MANOEUVRABILITY**

- 4 large diameter wheels : 2 fixed and 2 castors, 1 with brake.

**MAXIMUM STORAGE**

- Panel with special system for securing hammers and dressers.
- Other tools can be freely hung using the CKS system.
- 2 pull-out trays giving access to a "bin" for storing heavy tools, such as dollies and spoons, etc. Trays and bin fitted with a non-slip mat
- 3 drawers: (2 x 60 mm + 1 x 130 mm) and bin for storing bulky items and pneumatic tools.
- Compatible with the FACOM modular storage system.

**COMFORT**

- Working height.
- Ergonomic handle. Lid fitted with gas springs.



Supplied without tools and consumables.

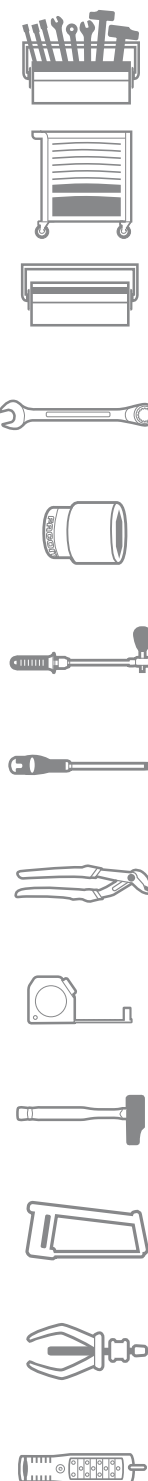

CR.T4XL Bodywork repair workstation



- A lid:
    - Containing a panel fitted with a system for securing dressers and hammers.
    - PK perforations for freely hanging other tools.
    - 2 gas springs for comfort of use.
  - 2 trays that pull out sideways to reveal a large bin for storing heavier tools such as dollies and spoons. The bottom of the trays and the bin are fitted with non-slip mats.
  - 3 drawers (2 x 60 + 1 x 130 mm) compatible with the Facom modular storage system and 1 bin drawer (270 mm high) for storing bulky items and pneumatic tools.
  - Galvanised steel worktop: easy-to-maintain and high resistance.
  - Safe: central key locking of lid and drawers.
  - Corner bumpers to avoid damage to vehicles in case of accidental contact.
  - Manoeuvrability ensured by 4 large diameter wheels, 2 fixed, 2 castors, one with a brake.
  - Dimensions, handle excluded (L. x D. x H.): 825 x 546 x 1,035 mm.
- Weight: 77 kg.

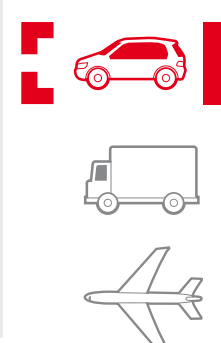

## Panel beating hammers

### 861D - Bumping hammers

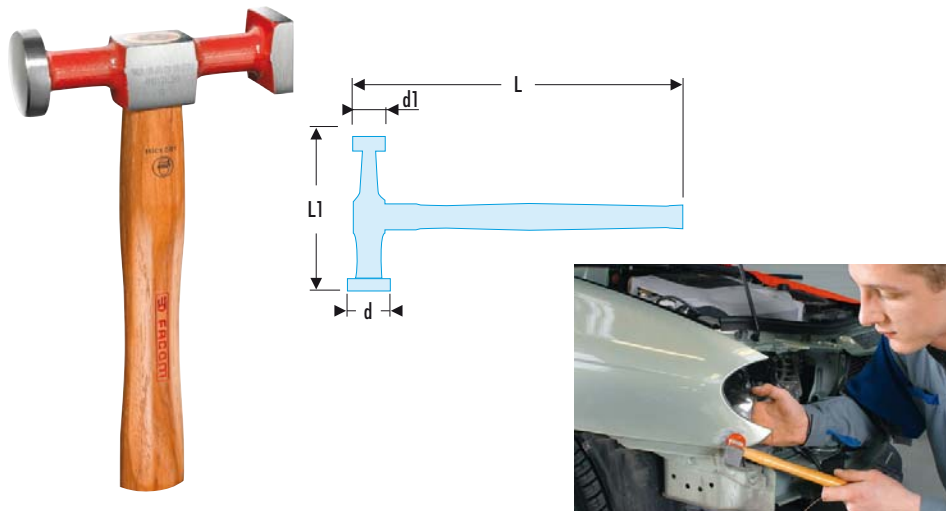

- Stretching and planishing hammer.
- Convex, round and square heads.
- Secure handle attachment.
- Finely polished planishing surfaces.
- Faceted hickory handle.

- Spare handle and wedge: 211.MH26.

	d [mm]	d1 [mm]	L [mm]	L1 [mm]	$\Delta\Delta$ [g]
<b>861D.26</b>	25	30	310	100	300
<b>861D.30</b>	30	35	310	100	390

### Round, flat, and convex head hammer

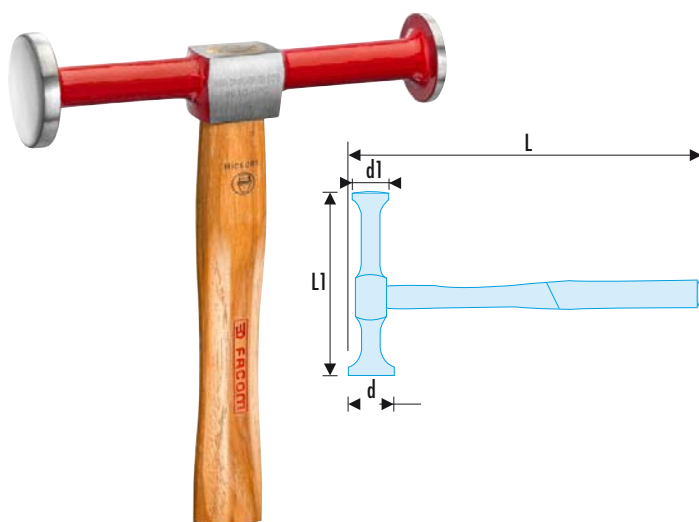

- Bumping and planishing hammer.
- Flat, round and convex heads.
- Secure handle attachment.
- Finely polished heads.
- Hickory handle.

- Spare handle and wedge: 211.MH26.

	d [mm]	d1 [mm]	E [mm]	L [mm]	L1 [mm]	$\Delta\Delta$ [g]
<b>861D.RPC</b>	32	40	40	310	150	600

### 866D - Shrinking hammers

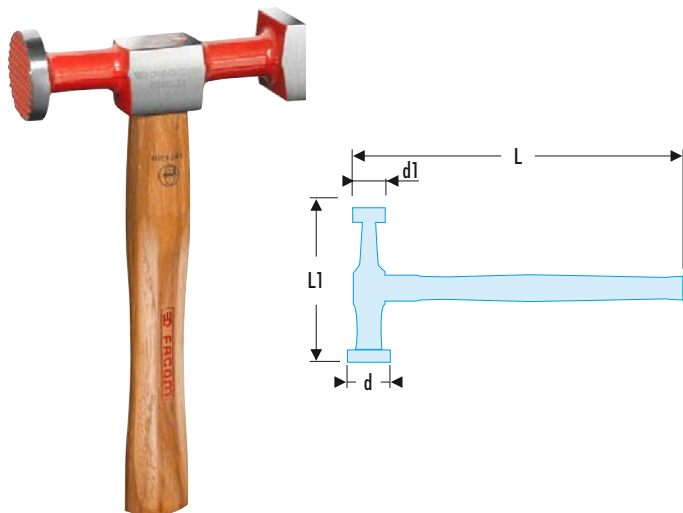

- Stretching and planishing hammer.
- 1 round ribbed face, one square smooth face.
- Secure handle attachment.
- Hickory handle.

- Spare handle and wedge: 211.MH26.

	d [mm]	d1 [mm]	L [mm]	L1 [mm]	$\Delta\Delta$ [g]
<b>866D.32</b>	30	35	310	100	310
<b>866D.41</b>	35	40	310	100	380

### Hammer with round flat face and straight pein

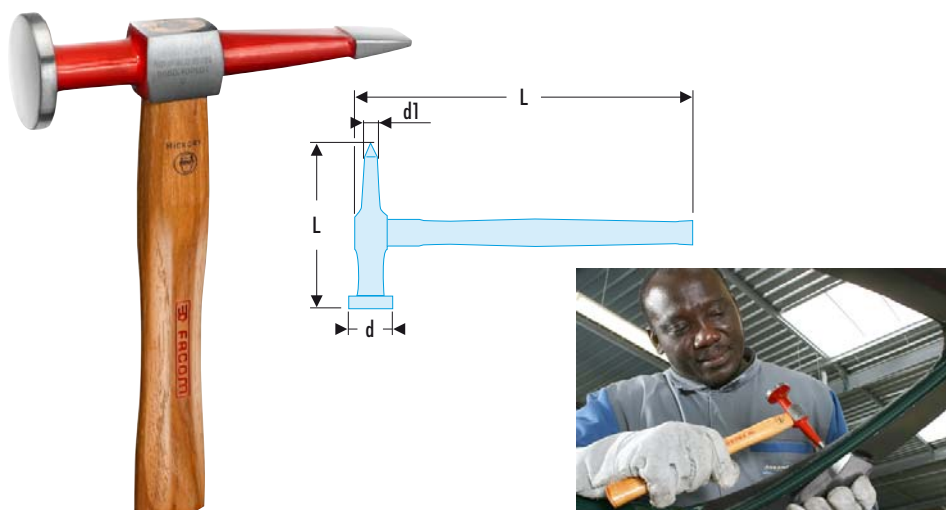

- Planishing hammer.
- 1 round flat face, 1 straight pein.
- Secure handle attachment.
- Finely polished head.
- Hickory handle.

- Spare handle and wedge: 211.MH26.

	d [mm]	d1 [mm]	L [mm]	L1 [mm]	$\Delta\Delta$ [g]
<b>868D.40PLD1</b>	40	23	310	140	320

Hammer with round domed face and curved pein

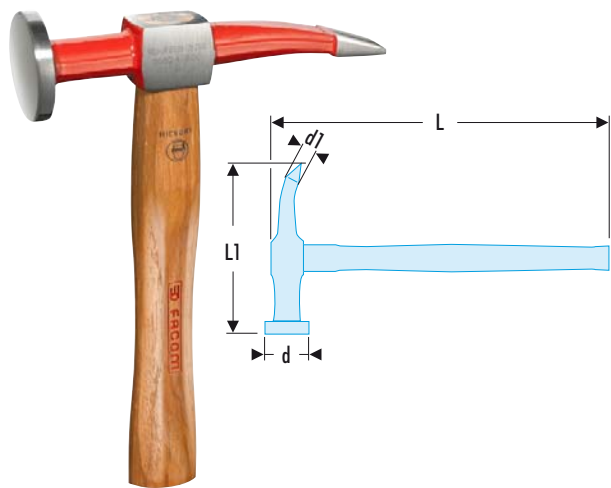

- Planishing hammer.
- 1 round domed face, 1 curved pein.
- Secure handle attachment.
- Finely polished head.
- Hickory handle.
- Spare handle and wedge: 211.MH26.

➤	d [mm]	d1 [mm]	L [mm]	L1 [mm]	ΔΔ [g]
<b>868D.40BOC</b>	40	23	310	23	430

Dressers

Flat dresser

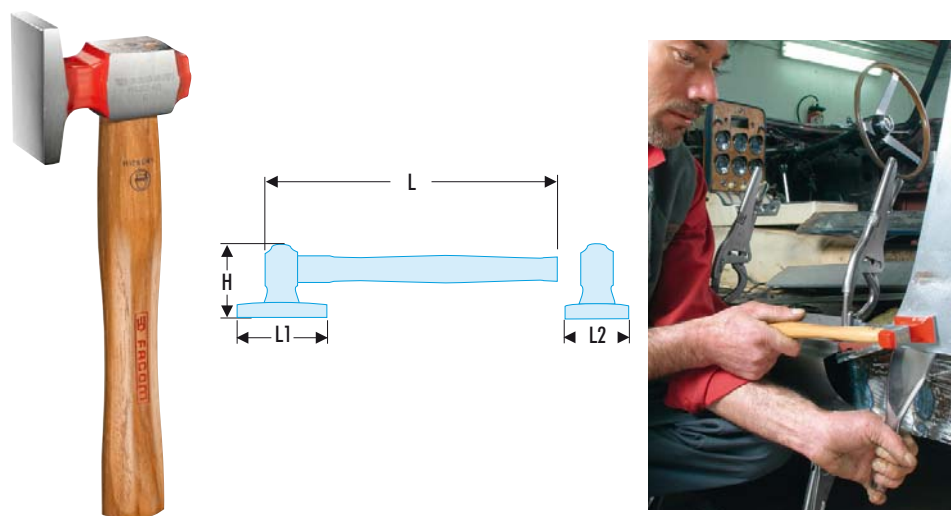

- Flat dresser.
- Secure handle attachment.
- Finely polished head.
- Hickory handle.
- Spare handle and wedge: 211.MH26.

➤	H [mm]	L [mm]	L1 [mm]	L2 [mm]	ΔΔ [g]
<b>862D.60</b>	70	295	50	30	320

Long-dome dresser

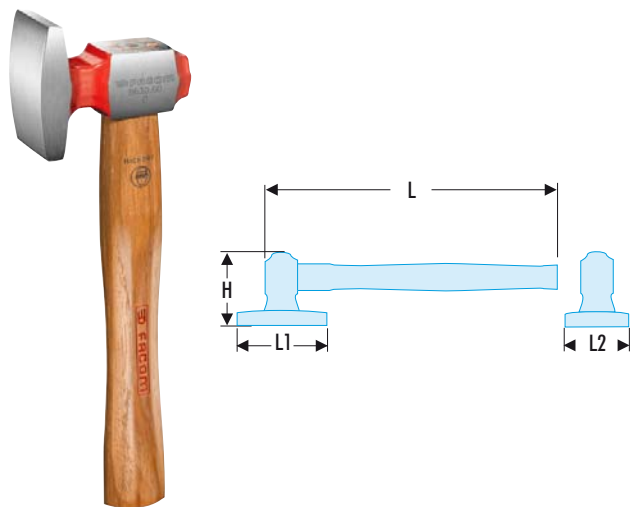

- Long-dome dresser.
- Secure handle attachment.
- Finely polished head.
- Hickory handle.
- Spare handle and wedge: 211.MH26.

➤	H [mm]	L [mm]	L1 [mm]	L2 [mm]	ΔΔ [g]
<b>863D.60</b>	70	295	50	30	320

Wide-dome dresser

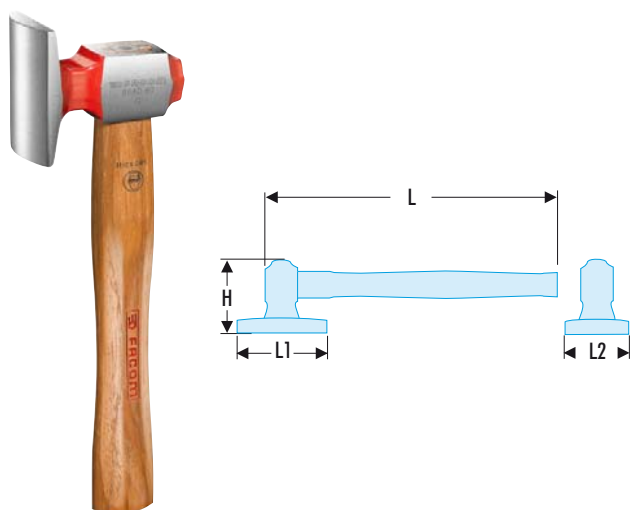

- Surface curved widthwise.
- Secure handle attachment.
- Finely polished head.
- Hickory handle.
- Spare handle and wedge: 211.MH26.

➤	H [mm]	L [mm]	L1 [mm]	L2 [mm]	ΔΔ [g]
<b>864D.60</b>	70	295	50	30	320

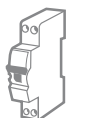
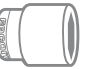
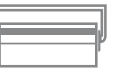



## Shrinking dresser no.1

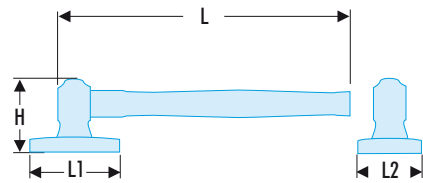

- Ribbed face.
- Secure handle attachment.
- Finely polished head.
- Hickory handle.

• Spare handle and wedge: 211.MH26.

➤	H [mm]	L [mm]	L1 [mm]	L2 [mm]	ΔΔ [g]
<b>867D</b>	70	295	50	30	310

## Shrinking dresser no.2

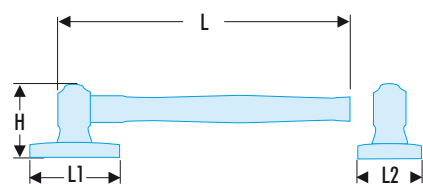

- Ribbed face.
- Secure handle attachment.
- Finely polished head.
- Hickory handle.

• Spare handle and wedge: 211.MH26.

➤	H [mm]	L [mm]	L1 [mm]	L2 [mm]	ΔΔ [g]
<b>867D.DS</b>	70	295	50	30	310

## Dollies

### 870A Regular dolly no.1



- Dimensions (L. x W. x H.): 88 x 60 x 35 mm.
  - Finish: polished.
- Weight: 1.115 kg.

### 870B Regular dolly no.2



- Combination of sharp and rounded edges.
  - Dimensions (L. x W. x H.): 90 x 55 x 35 mm.
  - Finish: polished.
- Weight: 1.150 kg.

### 870B Flat regular dolly



- Comprising one flat face, one curved face and an angle.
  - Dimensions (L. x W. x H.): 90 x 65 x 32 mm.
- Weight: 1.050 kg.

▣ 909A Slim shaping dolly



- Dimensions (L. x W. x H.): 88 x 60 x 23 mm.
- Finish: polished.
- Weight: 750 g.

▣ 871B.45 Slim wedge dolly



- Slim model with a domed face.
- Dimensions (L. x W. x H.): 125 x 55 x 37 mm.
- Finish: polished.
- Weight: 900 g.

▣ 871B.55 Wedge dolly



- Model with a domed face.
- Dimensions (L. x W. x H.): 140 x 54 x 55 mm.
- Finish: polished.
- Weight: 1.350 kg.

▣ 872A Curved head dolly



- Double-ended dolly, large model.
- Dimensions (L. x W. x H.): 90 x 70 x 125 mm.
- Finish: polished.
- Weight: 1.300 kg.

▣ 874A Dished dolly



- Curved on all sides.
- Dimensions (L. x W. x H.): 106 x 65 x 26 mm.
- Finish: polished.
- Weight: 980 g.

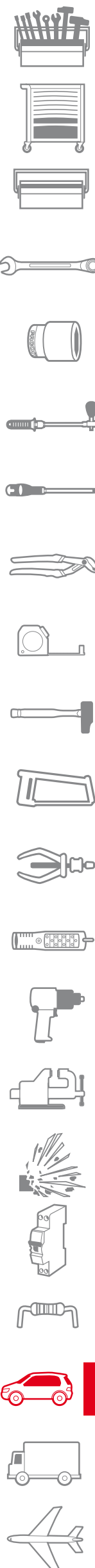

## ▣ 902B Thin toe dolly



- One curved face and one flat face.
  - Dimensions (L. x W. x H.): 115 x 56 x 25 mm.
  - Finish: polished.
- Weight: 860 g.

## ▣ 902C Toe dolly



- One curved face and one flat face.
  - Dimensions (L. x W. x H.): 125 x 60 x 30 mm.
  - Finish: polished.
- Weight: 1.370 kg.

## ▣ 906A Pinch wedge dolly



- One curved face and one flat face.
  - Dimensions (L. x W. x H.): 130 x 68 x 25 mm.
  - Finish: polished.
- Weight: 1.150 kg.

## Spoons and blades

### ▣ 875.3 Long single spoon



- Bumping spoon.
  - Length: 390 mm.
  - Finish: polished.
- Weight: 1.300 kg.

### ▣ 875.4 40° single spoon



- Bumping spoon.
  - Length: 250 mm.
  - Finish: polished.
- Weight: 500 g.

### ▣ 876A Angled, flat short double spoon



- Double bumping spoon, very cranked at one end.
  - Also available in a long version (ref: 877A, length: 510 mm).
  - Length: 400 mm.
  - Finish: polished.
- Weight: 1.700 kg.



877A Angled and flat double spoon



- Double bumping spoon, very cranked at one end.
- Also available in a short version (ref: 876A, length: 400 mm).
- Length: 510 mm.
- Finish: polished.
- Weight: 2.200 kg.

891A.PL Flat shrinking blade



- Ribbed face.
- Length: 350 mm.
- Weight: 700 g.

895A Short single spoon



- Bumping spoon.
- Length: 285 mm.
- Finish: varnished and polished.
- Weight: 820 g.

Files

851B Frame for milled files

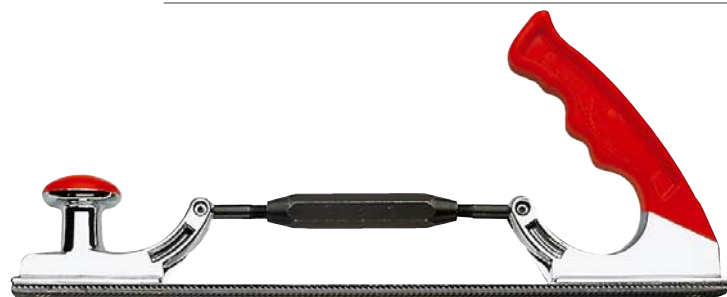

- Ergonomic handle with a choice of two working positions according to the task to be performed.
- Accurate setting of the file profile.
- Takes both 300 and 350 mm file lengths.
- Dimensions (L. x W. x H.): 360 x 33 x 140 mm.
- Supplied without file.
- Weight: 630 g.

850 milled files



- Recommended for soft metal, cast iron, mild steel and soft plastics.
- For use with frame 851B.

File	Size [mm]	L [mm]	l [mm]	Teeth [cm]	Blade profile	ΔΔ [g]
850.S300	Standard	300	30	31/2	Curved	190
850.S350	Standard	350	35	31/2	Curved	270
850.SD350	Standard	350	35	31/2	Straight	260
850.F350	Slim	350	35	41/2	Curved	270
850.EF350	Extra-slim	350	35	6	Curved	300

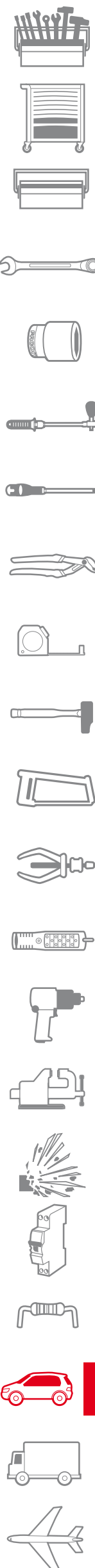

## Forming tool sets

### CR.CM92 135-piece bodywork tool set



- Set of forming tools.
  - Supplied without content, detail below.
- Weight: 20.340 kg.

Code	Qtys	Set Description
440.JP9	9	Combination wrenches 8 to 19 mm
R2NANO	38	1/4" sockets: 5.5 to 14 mm and accessories
SL.DBOX1	21	1/2" sockets: 8, 10 to 19, 21, 22, 24, 27, 30, 32 mm and accessories
AMZ.M1	1	Short bit holder
BP.102	1	Plastic case
ED.T	3	1/4" Pozidriv® tips 101-102-103
EH	4	1/4" 6-point tips 103 - 104 - 105 - 106
EP.T	3	1/4" Phillips® tips 101 - 102 - 103
ES.T	3	1/4" bits for slotted heads 134.5 - 136.5 - 148
EXR	6	1/4" Resistorx® tips 110 to 140
PL.400A	1	Plate for screwing bits
181A.25CPE	1	Lockable multigrip pliers
192.16CPE	1	Piano wire diagonal cutters
185.20CPE	1	Sheathed straight half-round nose pliers
501	1	Long-nose lock-grip pliers
893.316	1	Locking tape measure 3 m
234	1	Scriber
601	1	Hacksaw frame
668B.10	10	Saw blades
882A	1	Metal shears
RD.MD200EMA	1	Flat second-cut file 200 mm
DRD.MD200EMA	1	Half-round second-cut file 200 mm

Code	Qtys	Set Description
200H.50	1	Riveting hammer
208A.32CBA	1	Interchangeable-tip mallets
249	2	Drift punches 2 - 4 mm
256.6	1	Precision centre punch
259.P	1	Extra-flat chisel
861D.RPC	1	Round, flat, and convex head hammer
871B.45	1	Slim wedge dolly
861D.30	1	Bumping hammer
866D.32	1	Finishing hammer
868D.40BOC	1	Offset peening hammer
862D.60	1	Flat dresser
870B	1	Thin toe dolly
906A	1	Flat wedge dolly
875.3	1	Long single spoon
895A	1	Short single spoon
518.3	1	Lock-grip pliers
518.4	1	Lock-grip pliers
225.J3	3	End mills
851B	1	Frame for milled files
850.S350	1	Standard file
CR.D10	1	Windshield wiper arm remover
CR.D1	1	Trip removal tool

### CR.858J5 Specialist 5-piece forming tool set: a must-have



- Supplied without content, detail below.
- Weight: 3.880 kg.

Code	Qtys	Set Description
861D.30	1	Bumping hammer
862D.60	1	Flat dresser
870B	1	Thin toe dolly
906A	1	Flat wedge dolly
871B.45	1	Slim wedge dolly

**CR.858J15 Specialist 15-piece forming tool set: basic for professionals**



• Supplied without content, detail below.  
Weight: 11.850 kg.

Code	Qtys	Set Description
<b>868D.40BOC</b>	1	Offset peening hammer
<b>866D.32</b>	1	Finishing hammer
<b>861D.30</b>	1	Bumping hammer
<b>862D.60</b>	1	Flat dresser
<b>870B</b>	1	Thin toe dolly
<b>906A</b>	1	Flat wedge dolly
<b>871B.45</b>	1	Slim wedge dolly
<b>872A</b>	1	Curved head dolly

Code	Qtys	Set Description
<b>875.3</b>	1	Long single spoon
<b>876A</b>	1	Offset flat spoon
<b>895A</b>	1	Short single spoon
<b>891A.PL</b>	1	Flat shrinking blade
<b>851B</b>	1	Frame for milled files
<b>850.S350</b>	1	Standard file
<b>209.50</b>	1	Wood mallet

**CR.858J20 Specialist 20-piece forming tool set: a must-have for specialists**

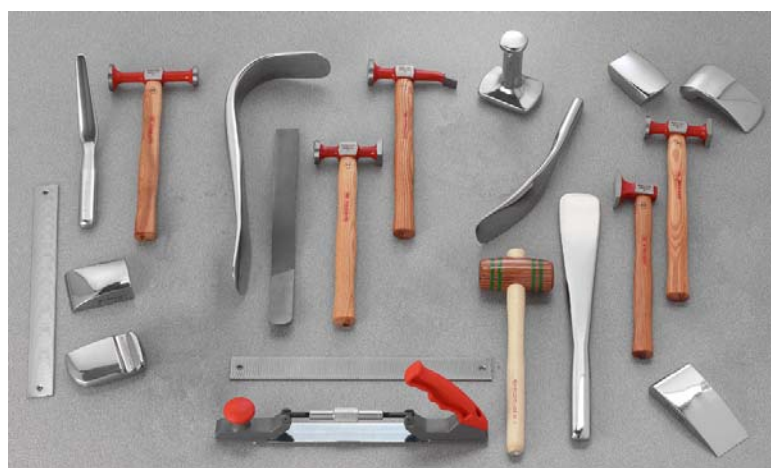

• Supplied without content, detail below.  
Weight: 15.120 kg.

Code	Qtys	Set Description
<b>868D.40BOC</b>	1	Offset peening hammer
<b>866D.32</b>	1	Finishing hammer
<b>861D.30</b>	1	Bumping hammer
<b>861D.RPC</b>	1	Round, flat, and convex head hammer
<b>862D.60</b>	1	Flat dresser
<b>870B</b>	1	Thin toe dolly
<b>906A</b>	1	Flat wedge dolly
<b>908A</b>	1	Flat regular dolly
<b>871B.45</b>	1	Slim wedge dolly
<b>874A</b>	1	Dished dolly

Code	Qtys	Set Description
<b>872A</b>	1	Curved head dolly
<b>875.3</b>	1	Long single spoon
<b>875.4</b>	1	40° single spoon
<b>876A</b>	1	Offset flat spoon
<b>895A</b>	1	Short single spoon
<b>891A.PL</b>	1	Flat shrinking blade
<b>851B</b>	1	Frame for milled files
<b>850.S350</b>	1	Standard file
<b>850.F350</b>	1	Fine file
<b>209.50</b>	1	Wood mallet

Modules

**MOD.CAR1A Bodywork module no.1**



• Comprising:  
- 861D.RPC: Hammer with round, flat and convex heads.  
- 902B: Thin toe dolly.  
- 909A: Slim shaping dolly.  
- 906A: Pinch wedge dolly.  
- Tray PL.396B.

• Spare handle and wedge: 211.MH26.

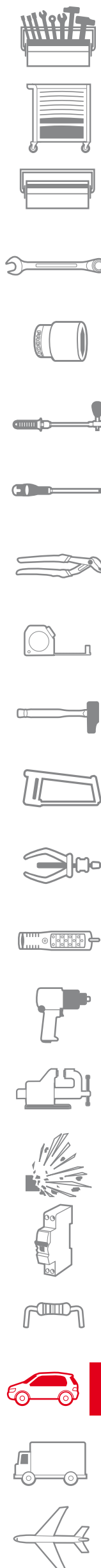



## MOD.CAR2 Bodywork module no.2



- Comprising:
  - 259: Slim-profile chisel 235 mm.
  - 209.50: Wooden mallet 50 mm.
  - 225.J3: Set of 3 end mills.
  - 850.S350: Standard angled milled file.
  - 851B: Frame for milled files.
  - 860H.28: Round head hammer 28 mm.
  - 861D.30: Bumping hammer.
  - 862D.60: Flat dresser.
  - 867D: Shrinking dresser.
  - 870B: Thin toe dolly.
  - 871B0.55: Wedge dolly.
  - 874A: Dished dolly.
  - 875.3: Long single spoon.
  - 906A: Pinch wedge dolly.
  - Thermoformed module PL.679 (value 3 modules).

## MOD.CARA Bodywork module no.3



- Comprising:
  - 225.J3: Set of 3 end mills.
  - 259.P: Slim-profile chisel with guard.
  - 501: Long nose self-tightening adjustable wrench.
  - 850.S350: Standard milled file.
  - 851B: Frame for milled files.
  - 862D.60: Flat dresser.
  - 875.3: Long single spoon.
  - 875.4: Angled spoon.
  - 884B: Panel shears.
  - 874A: Dished dolly.
  - Thermoformed module PL.379B (value 3 modules).
- Spare handle and wedge: 211.MH26.

## Pliers

### CAD.9 Hand punch



- Punch: 5 mm.
- Max. sheet thickness: 0.8 mm.
- Dimensions (L. x W. x H.): 290 x 130 x 30 mm.
- Weight: 1.170 kg.
- Punch and die, 5 mm diameter: CAD.10RN1.

### CAD.10 Hand crimper and punch



- Crimp width: 12 mm.
- Punch 5 mm.
- Swivel head.
- Max. sheet thickness: 0.8 mm.
- Dimensions (L. x W. x H.): 290 x 130 x 30 mm.
- Weight: 1.200 kg.
- Punch and die, 5 mm diameter: CAD.10RN1.

Paint preparation

PAINTING PREPARATION

SURFACE PREPARATION WORKSTATION

**EFFICIENT, MORE ORGANISED STORAGE**

- Specially designed to enable the user to perform surface preparation tasks in a minimum of time with a maximum of organisation.
- A clever storage system for keeping all the tools and consumables required for each job close to hand.
- Every day, you will appreciate the comfort, safety and organisation provided by its various features.
- Particularly appreciated for ISO 9000 certifications.

**EASY TO MAINTAIN**

- Galvanised steel worktop, resistant to chemical agents, solvents, etc. Removable lip.

**EVERYTHING CLOSE TO HAND**

- Bottle-shelf, paper-roll holder, waste bin, shelf for abrasives, adhesive rolls, etc: keeps everything within easy reach, at all times !

**CORNER BUMPERS**

- To avoid damage to vehicles in case of accidental contact !

**PADLOCK CLASP**



Supplied without tools and consumables

Supports

■ **CR.T3XL** Surface preparation workstation



- Workstation comprising:
  - 2 sloping upper shelves for storing consumables.
  - 1 drawer 130 mm high with padlock for expensive items, safety items, etc.
  - 1 2-way sloping shelf for ordinary tools.
  - 1 storage area for bulky consumables.
  - Perforated recessed side panels for attaching accessories: 2 bottle-shelves, 1 paper-roll holder, wire supports to hold paint guns, 1 waste bag holder.
- Dimensions, without handle (L. x D. x H.): 825 x 546 x 1645 mm.
- Weight: 51 kg.

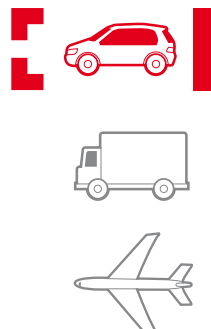
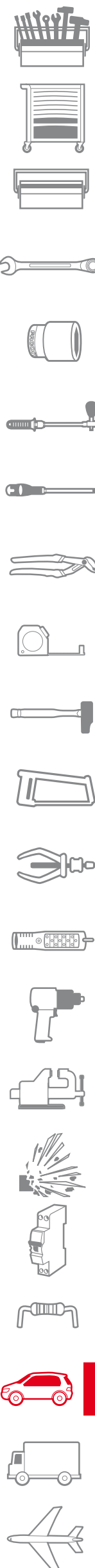



## CR.S7 Multi-functional bodywork support cradle



- Maximum supported weight by CR.S8: 80 kg.
- Foam protections to prevent scratches.
- Ergonomic design, flexible fabric sling moulds to the shape of the panel supported.
- 4 castor wheels (2 castors with brake).
- Floor dimensions.
- Easy to store.
- Dimensions (L. x W. x H.): 90 x 82 x 93 cm.
- Weight: 8 kg.

- Foam protection CR.S7PRO.
- Set of 2 slings CR.S7-05.

## CR.P1 Painters support



- Maximum supported weight by CR.S8: 50 kg.
- Multi-adjustable support for bonnets, doors, etc.
- Modular: 16-point adjustment, adjustable height, 360° rotation, with locking supports.
- With 2 large-size wheels.
- Small floor dimensions
- Dimensions (L. x W. x H.): 130 x 120 x 70 cm.
- Weight: 19 kg.

## CR.P2 Bodywork component horizontal stand



- Maximum supported weight by CR.S8: 80 kg.
- 3-point support stand with anti-scratch protection.
- Work height: min. 800 mm and max. 1100 mm.
- Small floor dimensions, easy storage.
- Weight: 8 kg.

- Foam protection CR.S7PRO.

## CR.S2 Support for work in high locations



- Maximum supported weight by CR.S8: 140 kg.
- Stepped support for work in high locations on utility vehicles, minivans, 4x4, etc.
- Safe use (safety bow, base stability).
- Easy to fold and store.
- Rear wheels with 2 positions (in axis or turned by 90°).
- Suited to paint booth gratings.
- Dimensions (L. x W. x H.): 80 x 100 x 200 mm.
- Weight: 37 kg.



Air tools

Angle sander diameter 178 mm

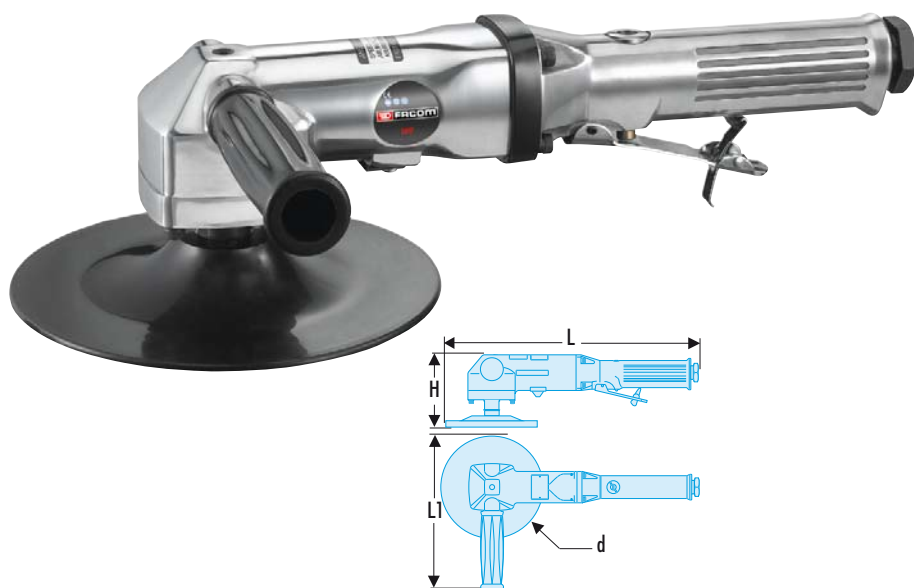

- Speed of rotation: 4500 rpm.
- Speed control.
- Average air consumption: 110 l/min.
- Air connection (female thread): 1/4".
- Pressure: 6.2 bar.
- Supplied with handle and one 178 mm dia. fibre pad.
- Pad: 178 mm. V.411FA1.

➤	d [mm]	L [mm]	L1 [mm]	H [mm]	ΔΔ [kg]
<b>V.411F</b>	178	373	229	101	2,250

Orbital sander 152 mm - 5 mm orbit

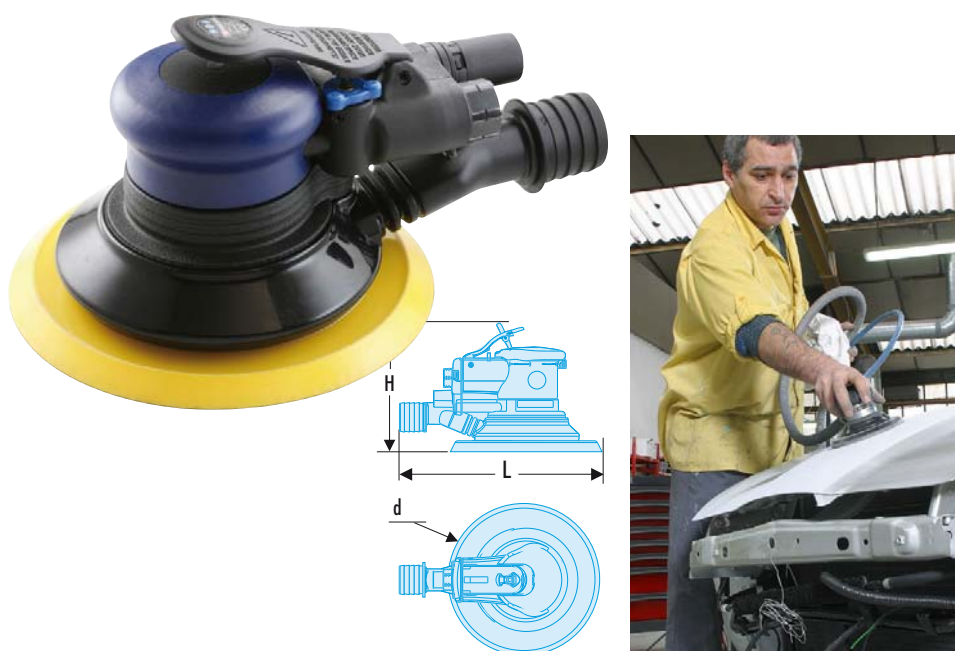

- Rotation speed control system.
- Can connect to a central exhaust unit.
- Speed of rotation: 10,000 rpm.
- Average air consumption: 105 l/mn.
- Air inlet thread: 1/4".
- Pressure: 6.2 bar.
- Orbit: 5 mm.
- Supplied with a 6-hole Velcro pad.
- Spare plate: V.252A1.

➤	d [mm]	L [mm]	H [mm]	ΔΔ [g]
<b>V.252F</b>	152	221	115	840

Vibrating sander - 95 x 170 mm - 8 holes



- Easy to handle, lightweight roughing sander.
- Clips for standard abrasives.
- Compatible with all diameters 29 mm dust exhaust.
- Variable speed control from 5000 to 8500 rpm.
- Air connection (female thread): 1/4".
- Recommended air hose (int. diam.): 8 mm.
- Recommended fitting: thread-internal diameter 1/4" - 6 mm.
- Pressure: 6.2 bar.
- Speed of rotation: 8500 rpm.
- Average air consumption: 115 l/min.
- Noise level: 74 dB(A).
- Vibration level: 5.4 m/s<sup>3</sup>.
- Eccentric offset: 5 mm.
- Finish: high-quality chrome-plated aluminium motor, comfortable thermally-insulated body.
- Supplied with pad and 8-hole abrasive perforator.

- 8 hole pad V.260A1.
- 95 x 170 mm pad V.260SAV50B.

➤	L [mm]	L1 [mm]	L2 [mm]	H [mm]	ΔΔ [kg]
<b>V.260F</b>	288	170	95	120	2,100

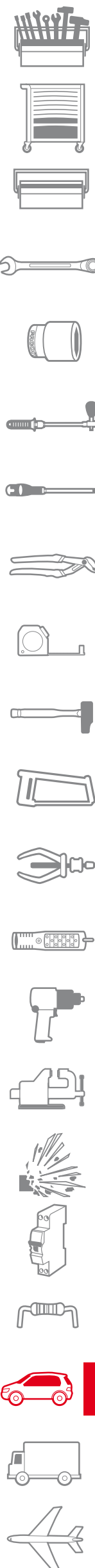
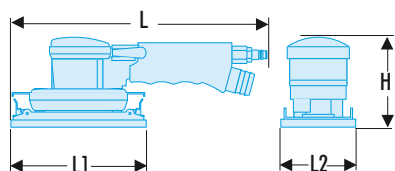

## ■ Belt sander - 10 x 330 mm

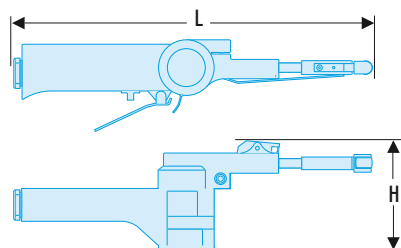

- Surface roughing and cleaning.
- Multi-position adjustable handle.
- Quick-change belt system.
- Belt size: 10 x 330 mm.
- Air connection (female thread): 1/4".
- Recommended air hose (int. diam.): 8 mm.
- Recommended fitting: thread-internal diameter 1/4" - 6 mm.
- Pressure: 6.2 bar.
- Speed of rotation: 16,000 rpm.
- Average air consumption: 110 l/min.
- Noise level: 86.1 dB(A).
- Vibration level: below 2.5 m/s<sup>3</sup>.
- Supplied with 3 belts (one ready-mounted):  
2 x 120 grit, 1 x 80 grit.
- 80 grit belt 10 x 330 V.781A1  
(minimum ordering quantity: 10).
- 120 grit belt 10 x 330 V.402A2  
(minimum ordering quantity: 10).

➤	L [mm]	H [mm]	ΔΔ [g]
<b>V.402F</b>	283	83	800

## AIR TOOLS



➤ Power tools section p. 676

Windshields

Windshield tools

CR.D10

WINDSHIELD WIPER ARM REMOVER

COMPACT, LIGHTWEIGHT,  
EASY TO USE

- Covers more than 95% of European vehicles.
- Chrome beam and legs.
- Legs can be adjusted in the same way as bearing pullers.



Special spacer for washer jet



CR.D10 Windshield wiper arm remover



- Including spacer for wiper arms with integral washer jet.
  - Each leg can be removed for a better fit on the arm.
  - Capacity diam.: 44 mm.
  - Supplied with instructions.
- Weight: 220 g.

D.28B Windshield replacement kit



- Comprising:
  - D.28A1: Suction cups (2x).
  - D.28A2: Ratchet strap.
  - D.28-3: Removal tool.
  - D.28-4: Pull handle.
  - D.28-5: Braided wire for windshields (18 m).
- Weight: 3.300 kg.

D.80 Windshield tools



- Set of 3 tools.
  - Comprising:
  - D.80-01: Windshield fitting tool.
  - D.80-02: Trim fitting tool.
  - 82H.4: Hexagon key (4 mm).
- Supplied in a plastic case, dim. (L. x W. x H.): 325 x 135 x 50 mm.
- Weight: 820 g.
- For narrow trim: D.80-02-04.
  - For medium trim: D.80-02-05.
  - For wide trim: D.80-02-06.

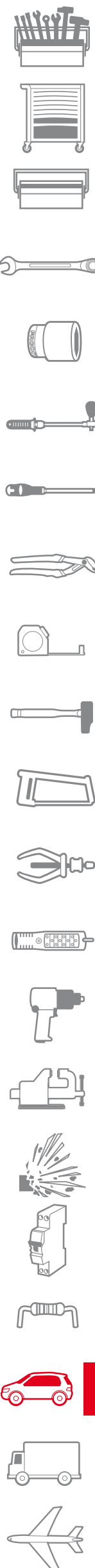



## DCR.20J6 Set of 6 suction cups



- Secures components while curing.
  - Many bodywork applications:
    - Windshield trims.
    - Names and badges.
    - Interior mirrors, etc.
  - Excellent suction on painted panels and windows.
- Weight: 470 g.

## Air tools

### Windshield cutter

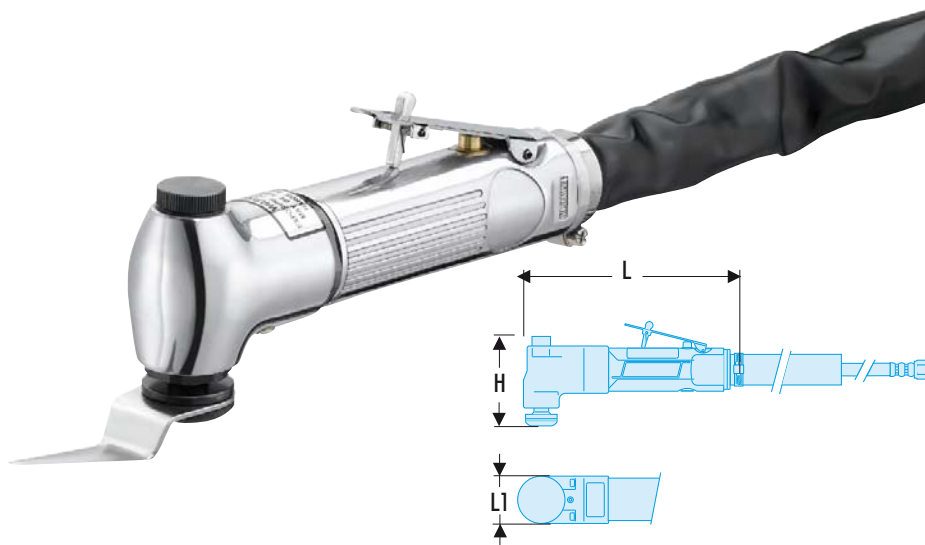

- Faster windshield replacement.
- Safety trigger.
- Air exhaust in handle.
- Air inlet thread: 1/4".
- Pendular motion: 3°.
- Strokes per minute: 2000.
- Average air consumption: 120 l/min.
- Air inlet thread: 10 mm.
- Supplied with instructions, without blade.

➤	L [mm]	L1 [mm]	H [mm]	ΔΔ [kg]
<b>CAD.P300F</b>	209	45	85	1,210

### Windshield cutter blades CAD.P300F



➤	L [mm]
<b>CAD.P300F1</b>	63
<b>CAD.P300F2</b>	30
<b>CAD.P300F3</b>	36
<b>CAD.P300F4</b>	57
<b>CAD.P300F5</b>	18
<b>CAD.P300F6</b>	35
<b>CAD.P300F7</b>	35
<b>CAD.P300F8</b>	90
<b>CAD.P300F9</b>	90
<b>CAD.P300F10</b>	25
<b>CAD.P300F11</b>	35
<b>CAD.P300F12</b>	45

## WINDSCREEN CUTTERS

- Using a ruler, measure the depth of glue to be cut, up to the windshield's printed markings.

**!** Select the corresponding blade, taking account of the rounded corners.

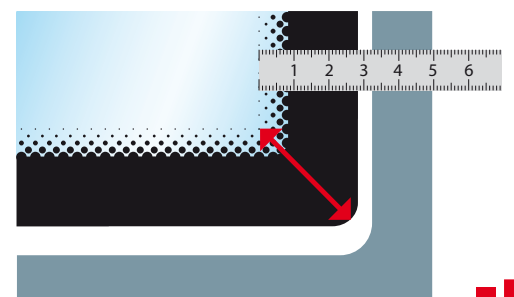

■ **Caulking gun - 50 x 215 mm cartridge**

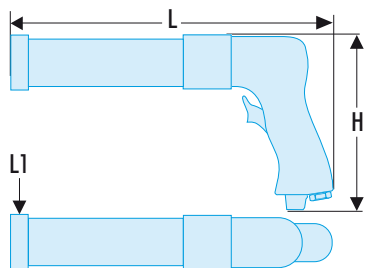
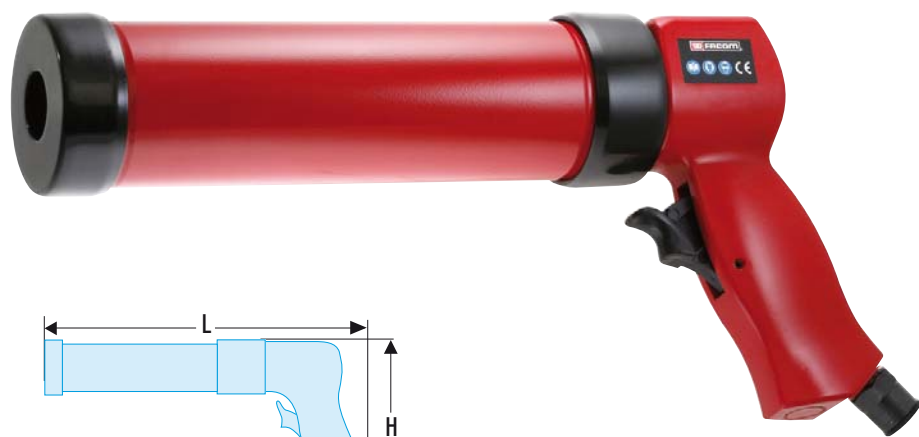

- For applying silicon, mastics, adhesives, etc.
- Variable flow.
- Automatic pressure release halting flow of mastic.
- Air connection: female thread 1/4".
- Recommended air hose: int. diameter 10 mm.
- Recommended fitting: thread-internal diameter 1/4" - 8 mm.
- Pressure: 6.2 bar.
- Noise level: 70 dB(A).
- Vibration level: below 2.5 m/s<sup>3</sup>.
- Standard cartridge: 50 x 215 mm.

	L [mm]	L1 [mm]	H [mm]	ΔΔ [kg]
<b>V.801F</b>	305	62	168	1,300

**Hydraulic equipment**

■ **CR.4T 4 T hydraulic straightening kit**



- Comprising:
  - 1 hand pump (270 cm<sup>3</sup>).
  - 1 push-jack (122 mm stroke).
  - 1 plier-spreader jack.
  - 5 extension pieces (115 to 534 mm).
  - 7 accessories: flat base, spreading legs, heads (V, chequered, rubber).
- Quick couplers.
- Working pressure: 700 bar.
- Supplied in a storage case.
- CE.
- Weight: 21.400 kg.

■ **CR.10T 10 T hydraulic straightening kit**



- Comprising:
  - 1 hand pump (600 cm<sup>3</sup>).
  - 1 push-jack (154 mm stroke).
  - 1 plier-spreader jack.
  - 4 extension pieces (127 to 711 mm).
  - 7 accessories: flat base, spreading legs, heads (V, chequered, rubber).
- Quick couplers.
- Working pressure: 700 bar.
- Supplied in a wheeled storage case.
- CE.
- Weight: 37.100 kg.

■ **WA.21 Hydraulic oil - 2 litres**



- 2 litre can.
- Suitable for hydraulic bodywork jacks, lifting jacks, cranes and pit jacks.

