



HAMMERS - MALLETS

562



Graphite handle hammer	562
Hickory handle hammers	566
Sledge hammers and mallets.....	570

SOFT FACE HAMMERS

571



Dead-blow hammers	571
Interchangeable-tip mallets	572

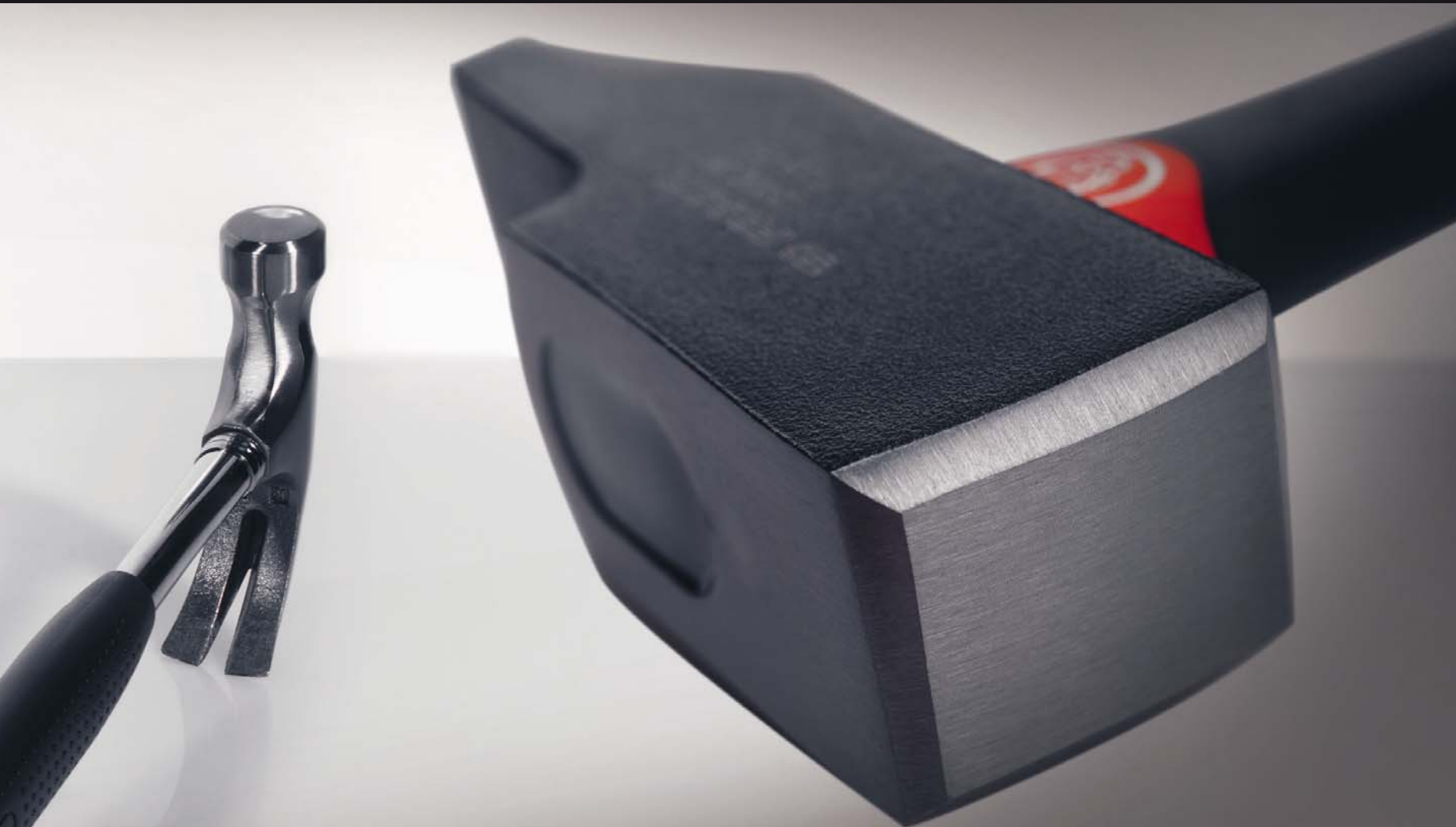

IMPACT TOOLS

574



Drifts	574
Poly-impact sets	575
Sheathed series impact tools	576
Drift punches	576
Nail-sets	576
Nail-sets	576
Centre punches	577



Sets and modules	577
Flat chisels - Cape chisels	582

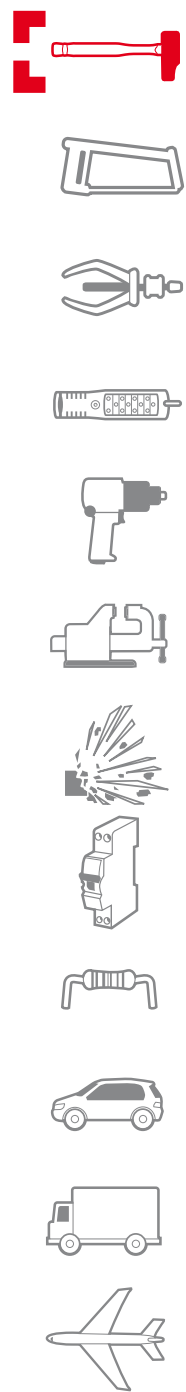

Graphite handle hammer



HAMMER WITH GRAPHITE HANDLE

THE SAFE HAMMER

Maximum safety.

- Permanent epoxy resin head-to-handle connection.
- Unbreakable.

Total comfort

- Anti vibration : absorbent material and narrow upper handle profile to reduce vibration.

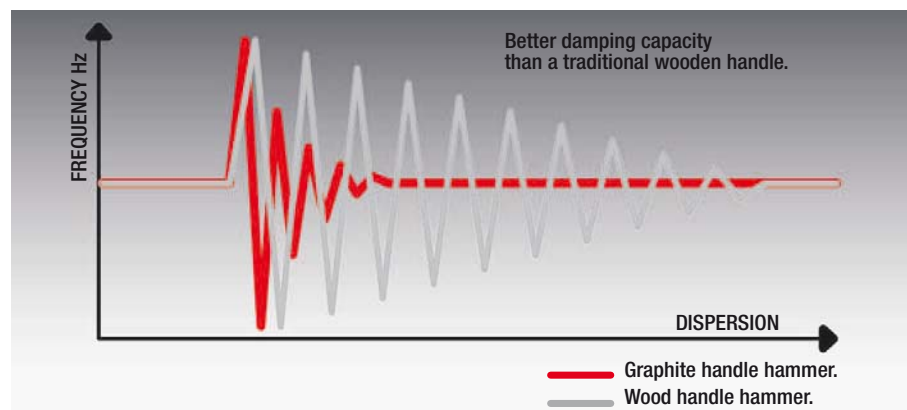

Positive grip

- Soft elastomer handle for a comfortable hold.
- Wide guard to prevent loss of grip.

A combination of 3 materials for a perfect result

1 - Graphite:

For strength. No risk of breakage.

2 - Polypropylene:

For reduced vibration.

3 - Elastomer:

For a perfect grip and excellent resistance to corrosive workshop liquids.

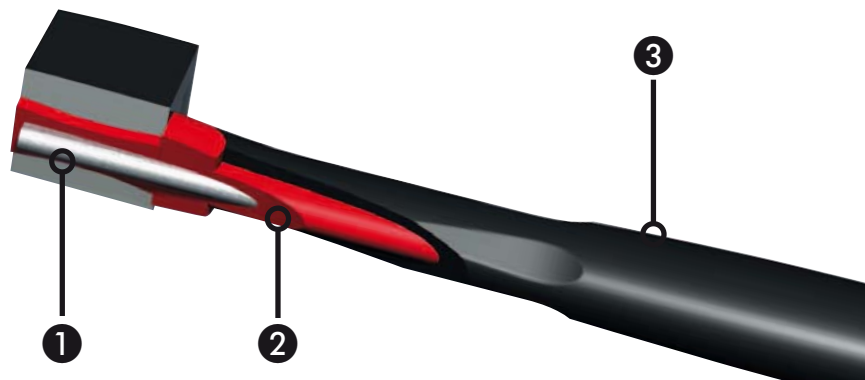

200 C

205 C



SAFETY FIRST

Wear eye protection.



200C - Graphite handle riveting engineers hammer

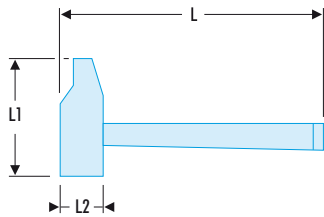

NF E 71-016, NF ISO 15601, ISO 15601

- Ergonomic safety handle with graphite core.

➤	L [mm]	L1 [mm]	L2 [mm]	ΔΔ [kg]
200C.26	245	80	25	0,345
200C.28	270	88	28	0,380
200C.30	270	93	30	0,470
200C.32	300	100	32	0,585
200C.36	300	106	35	0,725
200C.40	330	108	40	1,025
200C.42	330	117	42	1,130
200C.50	360	138	50	1,910
200C.60	380	151	60	2,800

205C - Graphite handle DIN engineers hammer

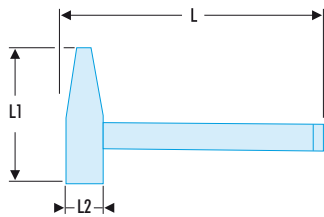

NF ISO 15601, ISO 15601, DIN 1041

- Ergonomic safety handle with graphite core.

➤	L [mm]	L1 [mm]	L2 [mm]	ΔΔ [kg]
205C.20	280	96	19	0,250
205C.30	300	106	23	0,380
205C.50	320	122	27	0,580
205C.80	350	132	33	0,960
205C.100	360	137	36	1,140



▣ MOD.MI7 Impact tools module 205C



- Comprising:
 - 205C.50: composite hammer 500 g.
 - 208A.32CB: steel mallet 32 mm.
 - 248. 4-5-6 mm: long drift punches.
 - 263.18: chisel.
 - 256.6: punch.
 - Heat-formed tray PL.333.
- Weight: 1.660 kg.

▣ MODM.MI5 Impact tools 205C long sheathed drift punches foam module



- Comprising:
 - 205C.50: DIN composite hammer 500 g.
 - 208A.32CB: steel mallet 32 mm.
 - 263.G19: sheathed chisel 190 mm.
 - 256.6: punch accuracy 6 mm.
 - 249.G 4 - 5 - 6 mm: 3 long-reach sheathed drift punches.
 - Foam tray PM.MODMI5.
- Weight: 1.750 kg.

▣ MODM.MI6 Impact tools 200C foam module



- Comprising:
 - 200C.40: composite riveting hammer 40 mm.
 - 208A.32CBA: steel mallet 32 mm.
 - 256.6: punch accuracy 6 mm.
 - 263.G19: sheathed chisel 190 mm.
 - 249.G 4 - 5 - 6 mm: sheathed drift punches.
 - Foam tray PM.MODMI6.
- Weight: 2.150 kg.

▣ MODM.MI7 Impact tools 205C long drift punches foam module



- Comprising:
 - 205C.50: DIN composite hammer 500 g.
 - 208A.32CBA: steel mallet 32 mm.
 - 256.6: punch accuracy 6 mm.
 - 263.18: chisel.
 - 248. 4 - 5 - 6 mm: long drift punches.
 - Foam tray PM.MODMI7.
- Weight: 1.700 kg.

WOOD HANDLE HAMMER

SAFE, ERGONOMIC AND COMFORTABLE

Head.

"High security" triple wedge handle attachment:

- 2 steel + 1 wooden wedge for a better distribution of contact surfaces between the handle and the head.

Head very firmly secured on the handle:

- Precise heat treatment of the head.

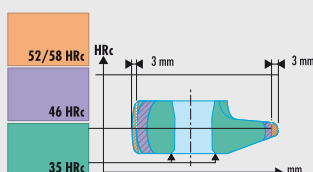

Handle.

Hickory:

- Excellent mechanical strength.
- Unaffected by climatic differences.

Octagonal handle profile:

- Exclusive to FACOM.
- Best compromise between mechanical strength and absorption of vibration.



GROWTH RING

Our handles are made only from blocks with a strictly defined number of growth rings : as this determines the rate of growth of the tree. Fast growth, few rings, low density wood and thus low mechanical strength.



Always inspect a hammer before use. If damaged in any way, discard it. Watch out for:

- Excessively worn or mushroomed head.
- Suspect fit.
- Scored handle.

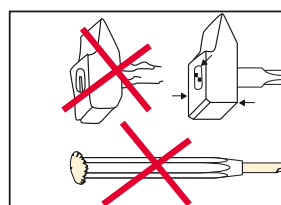

For safety, the hammer should hit dead square in the centre of the face.

Steady precise blows extend tool life.

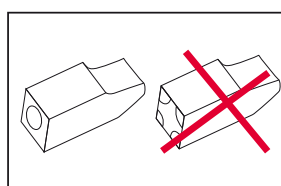

Flying chips are dangerous. Never hammer materials harder than 46 HRc. Use a FACOM mallet instead.

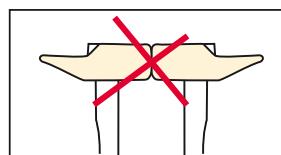
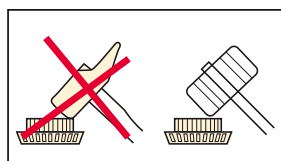

SAFETY FIRST

Wear eye protection.



Hickory handle hammers

200H - Riveting engineers hammers

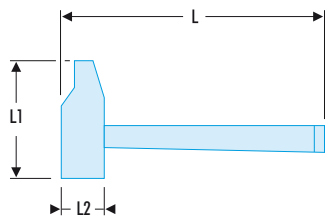

NF E 71-016, NF ISO 15601, ISO 15601

- "High safety" hickory handle, triple fit: 2 steel wedges and 1 wood wedge.

⇒	L [mm]	L1 [mm]	L2 [mm]	Handle	ΔΔ [kg]
200H.26	245	80	25	210.MHB01	0,345
200H.28	270	88	28	210.MHB02	0,380
200H.30	270	93	30	210.MHB03	0,470
200H.32	300	100	32	210.MHB04	0,585
200H.36	300	106	35	210.MHB04	0,725
200H.40	330	108	40	210.MHB05	1,025
200H.42	330	117	42	210.MHB05	1,130
200H.50	360	138	50	210.MHB06	1,910
200H.60	380	151	60	210.MHB27	2,800

MOD.MI1 Impact tools module 200H



- Comprising:
 - 200H.32: hickory riveting hammer 32 mm.
 - 208A.32CBA: steel mallet 32 mm.
 - 263.20: chisel.
 - 256.6: punch.
 - 248. 4 - 5 - 6 mm: long drift punches.
 - Heat-formed tray PL.333.
- Weight: 1.800 kg.

MODM.MI1 Impact tools 200H foam module



- Comprising:
 - 200H.40: hickory riveting hammer 40 mm.
 - 208A.32CBA: mallet.
 - 263.20: chisel.
 - 256.6: punch accuracy 6 mm.
 - 248. 4 - 5 - 6 mm: 3 long drift punches.
 - Foam tray PM.MODMI1.
- Weight: 1.800 kg.

205H - DIN engineers hammers

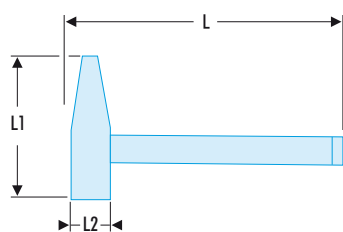

NF ISO 15601, ISO 15601, DIN 1041

- "High safety" hickory handle, triple fit: 2 steel wedges and 1 wood wedge.

⇒	L [mm]	L1 [mm]	L2 [mm]	Handle	ΔΔ [kg]
205H.20	280	96	19	210.MHB12	0,250
205H.30	300	106	23	210.MHB13	0,380
205H.50	320	122	27	210.MHB14	0,580
205H.80	350	132	33	210.MHB15	0,960
205H.100	360	137	36	210.MHB16	1,140

MOD.MI3 Impact tools module 205H



- Comprising:
 - 205H.50: DIN 500 g hickory hammer.
 - 208A.32CBA: steel mallet 32 mm.
 - 263.18: chisel.
 - 256.6: punch.
 - 248. 4 - 5 - 6 mm: 3 long drift punches.
 - Heat-formed tray PL.333.
- Weight: 1.710 kg

MODM.MI3 Impact tools 205H foam module



- Comprising:
 - 205H.100: DIN 1 kg hickory hammer.
 - 208A.32CBA: mallet.
 - 263.20: chisel.
 - 256.6: punch accuracy 6 mm.
 - 248. 4 - 5 - 6 mm: 3 long drift punches.
 - Foam tray PM.MODMI3.
- Weight: 1.800 kg.



WOOD HANDLE HAMMERS

IMPACT TOOL SAFETY:

- Check the condition of the tool before use.
- Do not use tools with traces of wear, mushrooming, scaling or cracks.
- Wear eye protection and gloves.

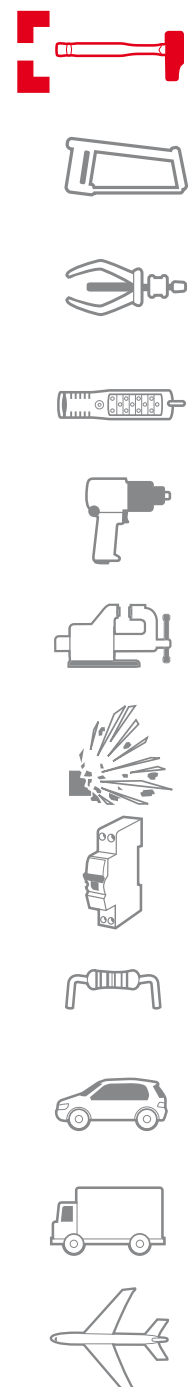

202H - Ball head engineers hammers

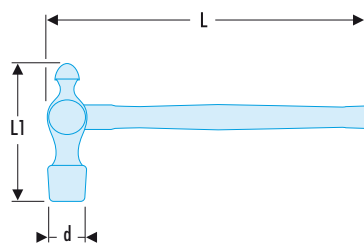

NF ISO 15601, ISO 15601, ASME B107.400

- "High safety" hickory handle, steel wedge.

Ref	d [mm]	L [mm]	L1 [mm]	Handle	$\Delta\Delta$ [kg]
202H.1/4	20	275	65	210.MHB07	0,140
202H.1/2	26	297	84	210.MHB08	0,280
202H.1	31	322	104	210.MHB09	0,430
202H.1'1/2	37	363	123	210.MHB10	0,840
202H.2	40	394	128	210.MHB11	1,110

MOD.MI4 Impact tools module 202H



- Comprising:
 - 202H.1/2: hickory American hammer.
 - 208A.32CBA: steel mallet 32 mm.
 - 263.18: chisel.
 - 256.6: punch.
 - 248. 4 - 5 - 6 mm: 3 long drift punches.
 - Heat-formed tray PL.333.
- Weight: 1.450 kg.

MODM.MI4 Impact tools 202H foam module



- Comprising:
 - 202H.1: 1LB: hickory American hammer.
 - 208A.32CB: steel mallet 32 mm.
 - 263.20: chisel.
 - 256.6: punch accuracy 6 mm.
 - 248. 4 - 5 - 6 mm: 3 long drift punches.
 - Foam tray PM.MODMI4.
- Weight: 1.800 kg.

860H - Dinging hammers, round face

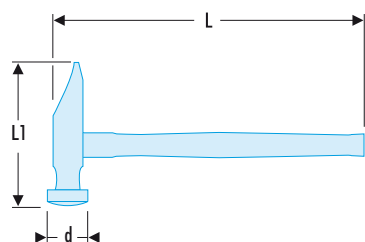

NF ISO 15601, ISO 15601

- "High safety" hickory handle, triple fit: 2 steel wedges and 1 wood wedge.

🚧	d [mm]	L [mm]	L1 [mm]	Handle	ΔΔ [kg]
860H.26	26	297	114	210.MHB26	0,340
860H.28	28	297	118	210.MHB26	0,370
860H.30	30	314	123	210.MHB28	0,440
860H.32	32	339	134	210.MHB29	0,570
860H.36	36	339	139	210.MHB29	0,700
860H.40	40	377	149	210.MHB31	0,920

Dinging hammer, square face

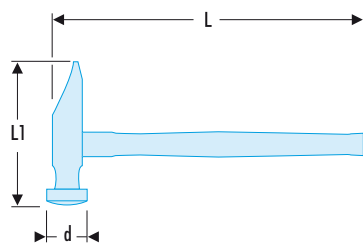

NF ISO 15601, ISO 15601

- "High safety" hickory handle, triple fit: 2 steel wedges and 1 wood wedge.

🚧	d [mm]	L [mm]	L1 [mm]	Handle	ΔΔ [kg]
859H.28	28	319	140	210.MHB34	0,560

213H - Welders chipping hammers

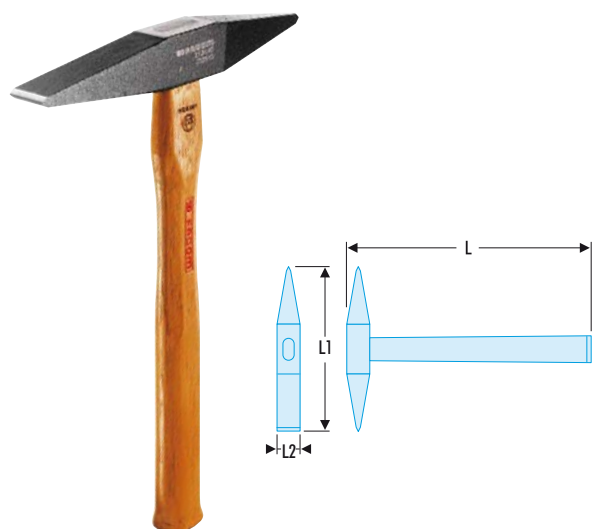

NF ISO 15601, ISO 15601, DIN 6465

- "High safety" hickory handle, triple fit: 2 steel wedges and 1 wood wedge.

➤	L [mm]	L1 [mm]	L2 [mm]	Handle	ΔΔ [kg]
213H.30	270	170	21	210.MHB32	0,340
213H.40	270	180	21	210.MHB32	0,480

203H - Electricians hammer

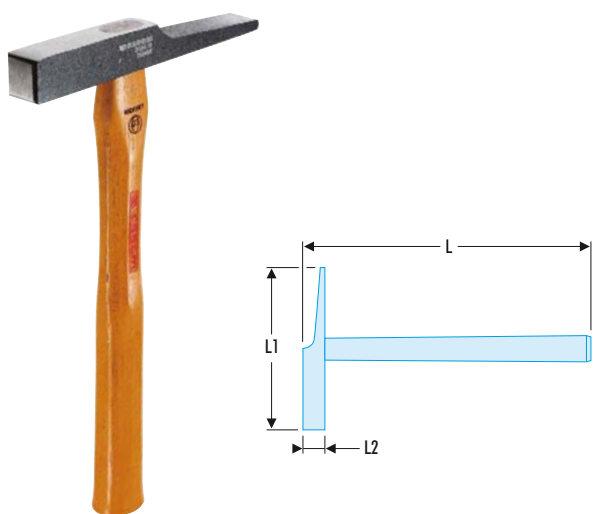

NF E 71-016, NF ISO 15601, ISO 15601

- "High safety" hickory handle, triple fit: 2 steel wedges and 1 wood wedge.

➤	L [mm]	L1 [mm]	L2 [mm]	ΔΔ [kg]
203H.16	237	141	16	0,160
203H.18	237	142	18	0,200

215H - Joiners hammers

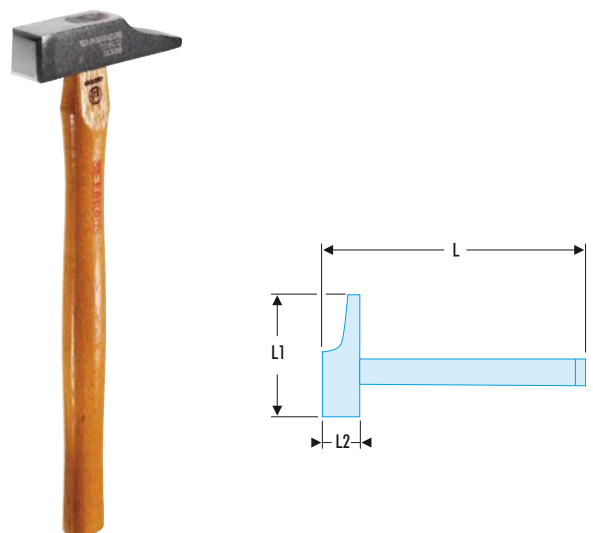

NF E 71-016, NF ISO 15601, ISO 15601

- "High safety" hickory handle, triple fit: 2 steel wedges and 1 wood wedge.

➤	L [mm]	L1 [mm]	L2 [mm]	ΔΔ [kg]
215H.20	264	91	20	0,210
215H.22	283	99	22	0,270
215H.26	285	109	26	0,360

Carpenters hammer



ASME B107.400

- Safety fit tubular handle, PVC grip.
- Head balanced with nail-puller peen.
- Presentation: polished finish.

➤	d [mm]	L [mm]	L1 [mm]	ΔΔ [kg]
204	30	335	130	0,810

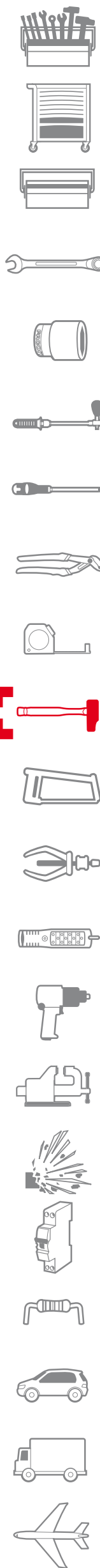

Sledge hammers and mallets

1262H - Beveled edge club hammers

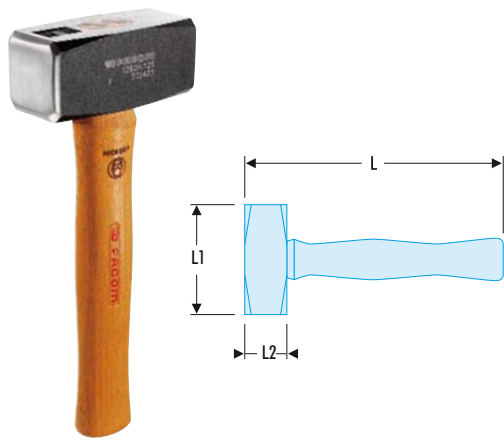

NF ISO 15601, ISO 15601, DIN 6475

- "High safety" hickory handle, triple fit: 2 steel wedges and 1 wood wedge.

➤	L [mm]	L1 [mm]	L2 [mm]	Handle	$\Delta\Delta$ [kg]
1262H.100	245	100	40	210.MHB22	1,000
1262H.125	248	105	43	210.MHB23	1,250
1262H.150	254	115	45	210.MHB24	1,500

High load club hammer

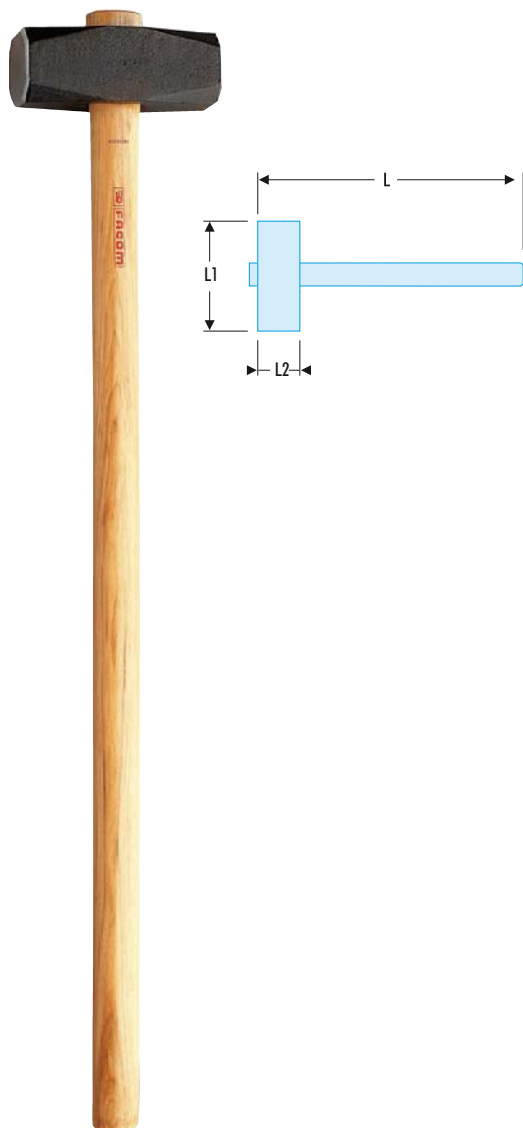

NF ISO 15601, ISO 15601, DIN 6475

- "High safety" hickory handle.

➤	L [mm]	L1 [mm]	L2 [mm]	Handle	H [mm]	$\Delta\Delta$ [kg]
1263H.400	880	175	60	210.MHB35	60	4,800

209 - Wooden mallets

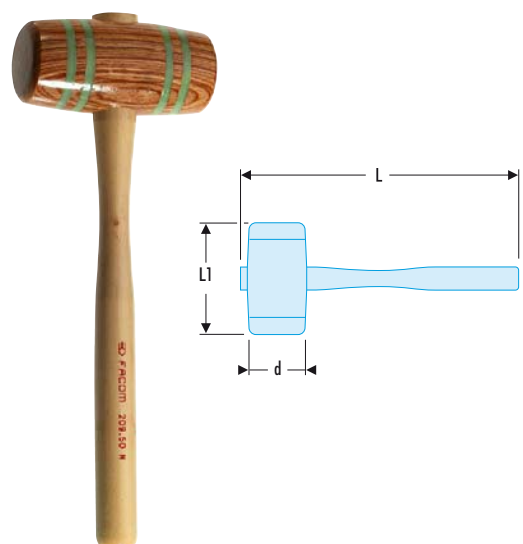

DIN 7462

- Model in compressed laminated wood.
- Shrunk-on rings embedded in glass fiber.
- Horn-beam handle.

➤	d [mm]	L [mm]	L1 [mm]	$\Delta\Delta$ [kg]
209.50	50	290	100	0,320
209.60	60	320	120	0,500

Dead-blow hammers

DEAD-BLOW HAMMERS

SAFE, ERGONOMIC AND COMFORTABLE

Deadening the blow

The head is half-filled with steel balls, the mass of which has sufficient inertia to counteract any tendency to bounce back. After striking, the face of the hammer remains in position, without the damaging effects of rebound when hammering home an accurate fit. The nylon or polyurethane striking faces remove the risk of lying chips when hitting hard metal objects.

"Monobloc" hammer in polyurethane

- In addition to the dead-blow feature the soft-face hammer 216 is fully moulded in a polyurethane shell.
- This monobloc design protects the head from splitting and the balls escaping in the workshop.
- The chemical-resistant polyurethane moulding gives the tips a far longer service life than conventional soft-faced hammers.

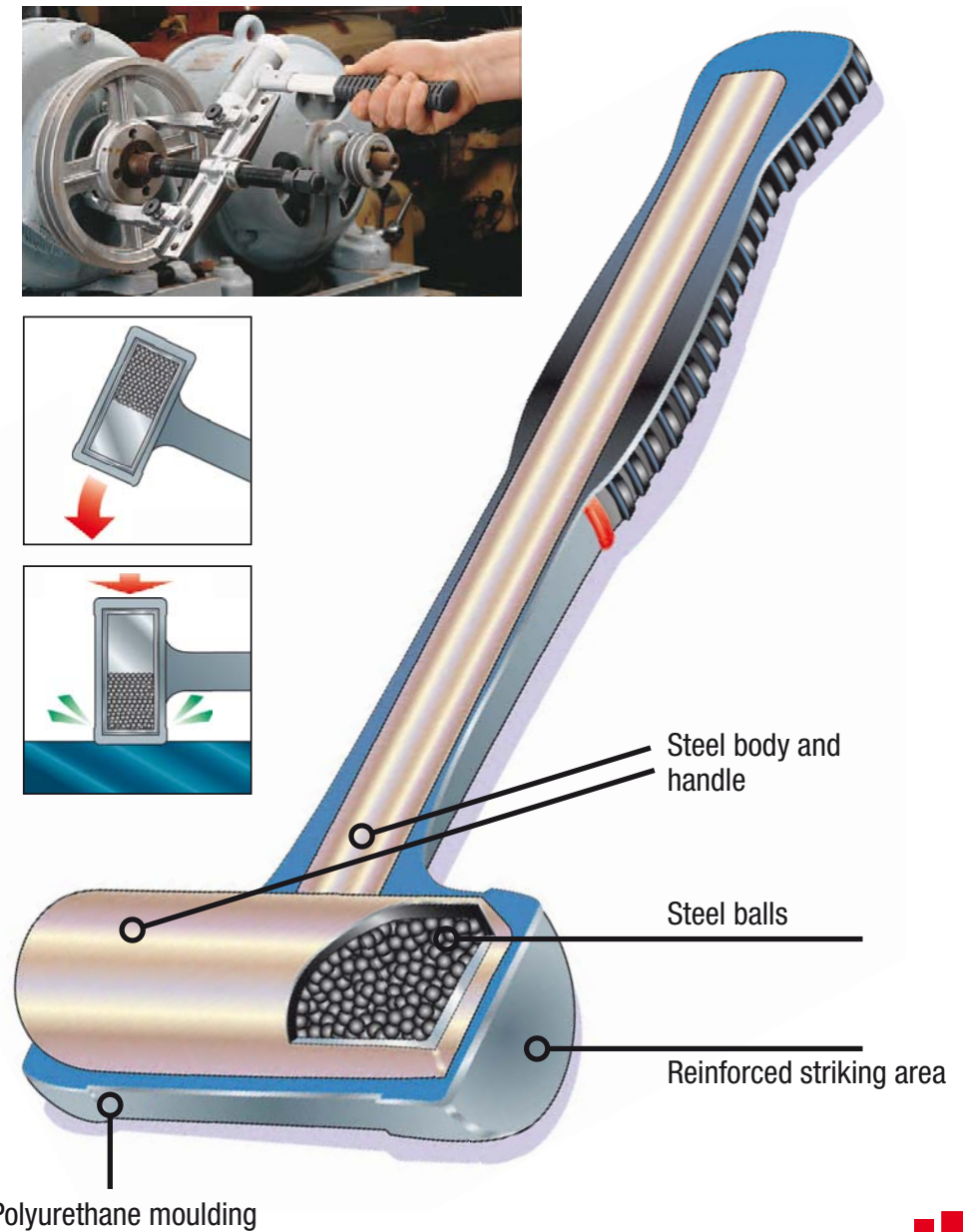
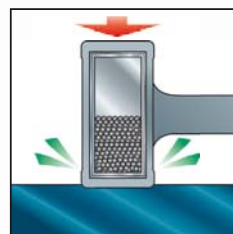
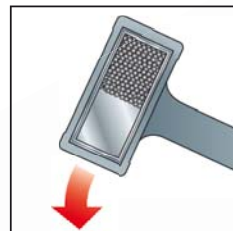

216 - One-piece dead-blow hammers

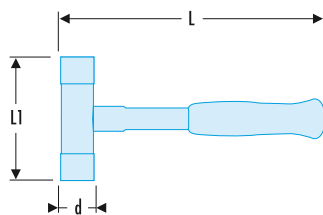

- Dead-blow hammer with steel microballs.
- Body and handle in steel coated with polyurethane.
- D45 ± 5 shore hardness impact surface.
- Ergonomic PVC grip.

	d [mm]	L [mm]	L1 [mm]	ΔΔ [kg]
216.40	40	298	110	0,657
216.50	50	308	115	0,888
216.60	60	316	120	1,316



212A - Dead-blow hammers, interchangeable tips

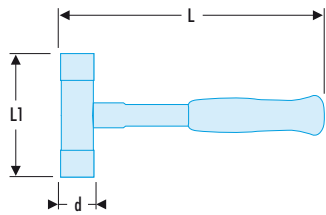

- Glass fiber handle.
- Steel body.
- Easily replaceable, special nylon tips shore hardness D74 ± 5.
- Ergonomic PVC grip.
- Presentation: black epoxy.
- Spare tip: 212.E35 to E60.

212	d [mm]	L [mm]	L1 [mm]	Bits	ΔΔ[kg]
212A.35	35	305	112	212.E35	0,698
212A.40	40	310	117	212.E40	0,839
212A.50	50	320	120	212.E50	1,143
212A.60	60	330	145	212.E60	1,664

Adaptable-tip mallets

INTERCHANGEABLE-TIP MALLETS

IMPACT TOOL SAFETY:

- Check the condition of the tool before use.
- Do not use tools with traces of wear, mushrooming, scaling or cracks.
- Wear eye protection and gloves.



207A-208A - Adaptable-tip mallets



207A: Aluminum body "light" series hammers.
208A: Steel body "heavy" series hammers.

- Mallets are available with a limited number of tip combinations only, but you can customize your mallet by selecting a body and two tips of your choice.
- Tips available:
 - EA series: neoprene.
 - EB series: polyurethane.
 - EC series: nylon.

207	d [mm]	Finish	Bits	ΔΔ[kg]
207A.25CB	25	Aluminium	EC - EB	0,135
207A.32CB	32	Aluminium	EC - EB	0,210
207A.40CB	40	Aluminium	EC - EB	0,350
207A.50CB	50	Aluminium	EC - EB	0,560
207A.60CB	60	Aluminium	EC - EB	0,840
208A.25CBA	25	Mosiξdz	EC - EB	0,220
208A.32CBA	32	Mosiξdz	EC - EB	0,345
208A.32BBA	32	Mosiξdz	EB - EB	0,350
208A.40CBA	40	Mosiξdz	EC - EB	0,615
208A.40CCA	40	Mosiξdz	EC - EC	0,620
208A.50CBA	50	Mosiξdz	EC - EB	1,000
208A.60CBA	60	Mosiξdz	EC - EB	1,550

207A-208A - Mallet tips



207A: Lightweight aluminum body, hickory handle.
208A: Heavyweight steel body, hickory handle.

⇒	d [mm]	L [mm]	Handle	Finish	ΔΔ[kg]
207A.25	25	280	210.MHB12	Aluminium	0,110
207A.32	32	300	210.MHB13	Aluminium	0,160
207A.40	40	323	210.MHB14	Aluminium	0,270
207A.50	50	350	210.MHB15	Aluminium	0,410
207A.60	60	363	210.MHB16	Aluminium	0,610
208A.25A	25	280	210.MHB12	Mosiξdz	0,200
208A.32A	32	300	210.MHB13	Mosiξdz	0,295
208A.40A	40	323	210.MHB14	Mosiξdz	0,510
208A.50A	50	350	210.MHB15	Mosiξdz	0,830
208A.60A	60	363	210.MHB16	Mosiξdz	1,300

Spare tips for mallets



EA



EB



EC

- Tips:
EA: neoprene tips, hardness shore A75.
Replaces rubber mallets.
EB: thermoplastic polyurethane tips (TPU), hardness shore D56.
Replaces wood and leather mallets.
EC: nylon tips, hardness shore D68.
Replaces soft metal mallets (copper, lead, brass, aluminum).

⇒	d [mm]	Color	Bits
EA.25	25	Black	Neopren
EA.32	32	Black	Neopren
EA.40	40	Black	Neopren
EA.50	50	Black	Neopren
EA.60	60	Black	Neopren
EB.25	25	Red	TPU
EB.32	32	Red	TPU
EB.40	40	Red	TPU
EB.50	50	Red	TPU
EB.60	60	Red	TPU
EC.25	25	White	Nylon
EC.32	32	White	Nylon
EC.40	40	White	Nylon
EC.50	50	White	Nylon
EC.60	60	White	Nylon

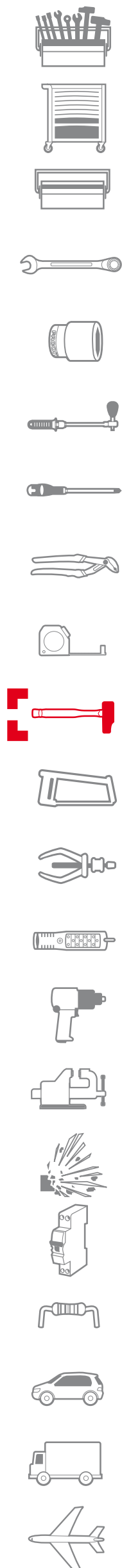

Punches and nail sets

214 - Standard drifts



- Steel body.
- Replaceable nylon tips shore hardness D74.
- Use with a hammer or by hand to fit or extract small parts or bearings.
- Replaces bronze or brass drifts.

➤	d [mm]	L [mm]	Bits	ΔΔ[kg]
214.10	10	166	212.E10	0,100
214.15	15	175	212.E15	0,200

214.R - Dead-blow drifts



- Steel body with dead-blow design: the body is filled with steel balls preventing rebound after the shock.
- Replaceable nylon tips shore hardness D74.
- These large drifts can be used directly by hand to place parts delicately.

➤	d [mm]	L [mm]	Bits	ΔΔ[kg]
214.R20	20	150	212.E20	0,220
214.R25	25	153	212.E25	0,330
214.R30	30	157	212.E30	0,460
214.R35	35	157	212.E35	0,620

Multi-impact tool sets

MULTI-IMPACT SYSTEM

DRIFTS AND PUNCHES

Parts protection

- Interchangeable tips of different hardness for parts that must not be marked.
- High quality, precision tools.

Multi-solution

- Tips of 3 different materials: brass, aluminium and polyamide.
- Extensive range of sizes.

Comfort and safety

- Exclusive sheathed, shock-absorbing handle.
- Slide-action for an increased shock-absorbency.
- Positive grip.

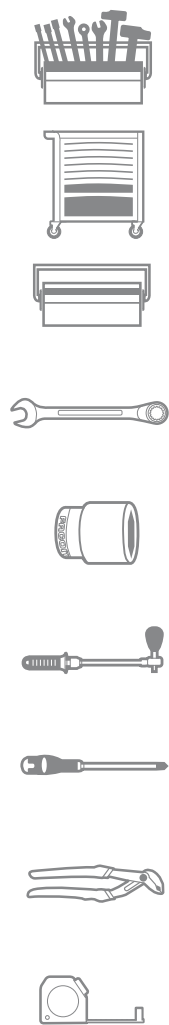
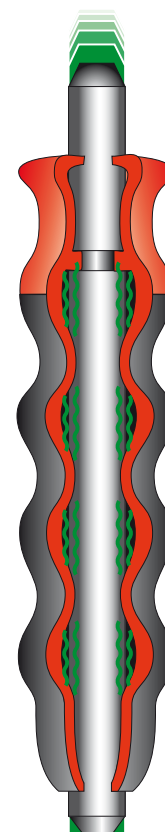

217.GJ1 Drifts set - 3 materials: Brass-Polyamide-Aluminum



- Capacity Ø 10 to 20 mm.
- Sets of 19 pieces comprising:
 - 1 anti-vibration sheathed grip 217.G16.
 - 5 aluminum drift punch tips Ø 10, 12, 14, 16, 18 mm; useful length: 60 mm.
 - 3 brass tips Ø 12, 16, 20 mm; useful length: 40 mm.
 - 3 polyamide tips Ø 12, 16, 20 mm; useful length: 40 mm.
 - one extension useful length 100 mm.
 - 3 bits for extension: brass Ø 12, 16, 18 mm; useful length: 20 mm.
 - 3 bits for extension: polyamide Ø 12, 16, 18 mm; useful length: 20 mm.
- Packaged in plastic case 265 x 230 x 50.
- Weight: 1.350 kg.

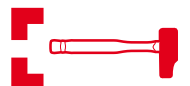

Extension

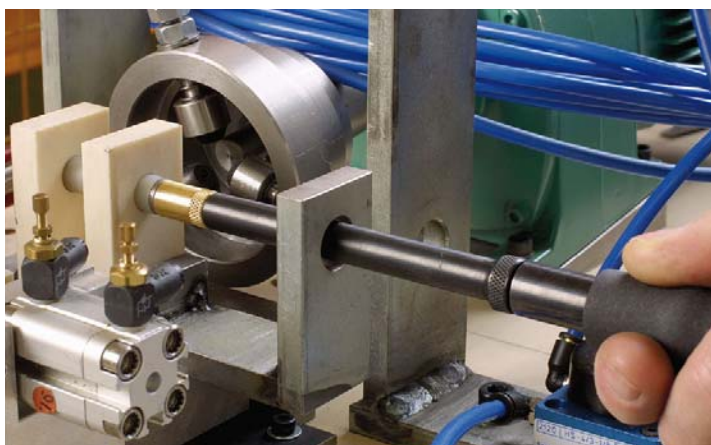

- M8 threaded bit holder extension.

	d [mm]	L [mm]	ΔΔ [kg]
217.R12	12	125	0,105

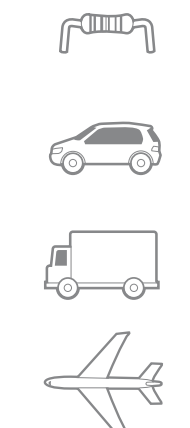

Sheathed series

SHEATHED SERIES - A STEP FORWARD

NEW ULTRA-COMFORTABLE ANTI-ROLL SHEATH

Ergonomic

- Shock-absorbing.
- Elastic sheath. Partly free-sliding sheath.
- More stable, more positive grip.
- Protects the hand.

Safe

- Choice of best steels.
- Very precise heat treatment with different harnesses.
- DIN 7255.
- FACOM specifications.
- Better shock absorbance and elasticity to avoid the risk of breakage.

Precise and Powerful

- Comfortable grip ensures an accurately aimed blow.
- Stability of tool ensures a more powerful blow.

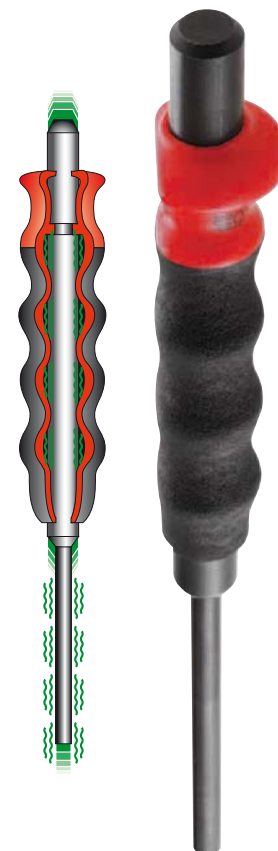

249G - Sheathed drift punches

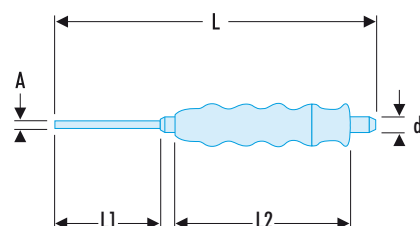

- Long shank.
- Head hardened to 43 HRc.
- Shank hardened to 58 HRc.

➤	A [mm]	d [mm]	L [mm]	L1 [mm]	L2 [mm]	ΔΔ [kg]
249.G2	1,95	8	140	35	105	0,088
249.G3	2,95	8	150	45	105	0,090
249.G4	3,95	10	190	60	105	0,094
249.G5	4,95	10	200	70	105	0,098
249.G6	5,90	12	210	80	105	0,142
249.G8	7,90	12	216	86	105	0,158
249.G10	9,80	14	230	100	105	0,181
249.G12	11,80	16	280	130	105	0,380
249.G14	13,80	18	290	140	105	0,490
249.G16	15,70	18	310	160	105	0,580

247G - Sheathed nail sets

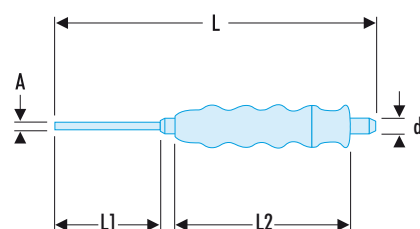

- Head hardened to 36 - 44 HRc.
- Tip hardened to 52 - 60 HRc.

➤	A [mm]	d [mm]	L [mm]	L1 [mm]	L2 [mm]	ΔΔ [kg]
247.G2	1,9	10	185	55	105	0,102
247.G3	2,9	10	185	55	105	0,106
247.G4	3,9	10	185	55	105	0,109
247.G5	4,9	10	185	55	105	0,112
247.G6	5,9	10	185	55	105	0,115
247.G8	7,8	12	185	55	105	0,173

255G - Sheathed centre punches

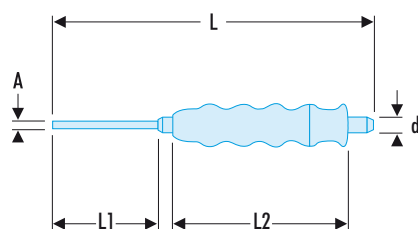

- Head hardened to 36 - 44 HRc.
- Tip hardened to 57 - 60 HRc.

➤	A [mm]	d [mm]	L [mm]	L1 [mm]	L2 [mm]	ΔΔ [kg]
255.G2,5	2,5	10	185	55	105	0,104
255.G4	4	10	185	55	105	0,110
255.G6	6	10	185	55	105	0,116
255.G8	8	12	185	55	105	0,174
255.G10	10	14	185	55	105	0,210

Sets of sheathed impact tools



- Sets of punches and nail sets.

➤	Content set
249.GJ5	249.G3 - G4 - G5 - G6 - G8
249.GJ7	249.G2 - G3 - G4 - G5 - G6 - G8 - G10
249.G247GJ12	249.G2 - G3 - G4 - G5 - G6 - G8 247.G2 - G3 - G4 - G5 - G6 - G8
249.GJ4	249.G10 - G12 - G14 - G16

MOD.CG Sheathed drift punches module



- Comprising:
 - 249.G 2 - 3 - 4 - 5 - 6 - 8 mm: 6 drift punches.
 - 247.G. 4 - 5 - 6 - 8 mm: 4 nail sets.
 - 255.G6: punch.
 - Heat-formed tray PL.334.
- Weight: 1.470 kg.

MODM.CG Sheathed drift punches foam module

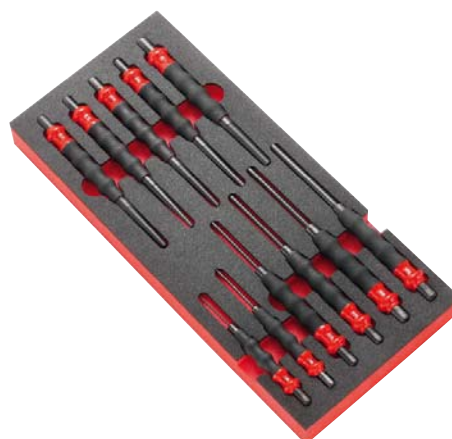

- Comprising:
 - 249.G 2 - 3 - 4 - 5 - 6 - 8 mm: 6 drift punches.
 - 247.G 4 - 5 - 6 - 8 mm: 4 nail sets.
 - 255.G6: punch accuracy 6 mm.
 - Foam tray PM.MODCG.
- Weight: 1.470 kg.

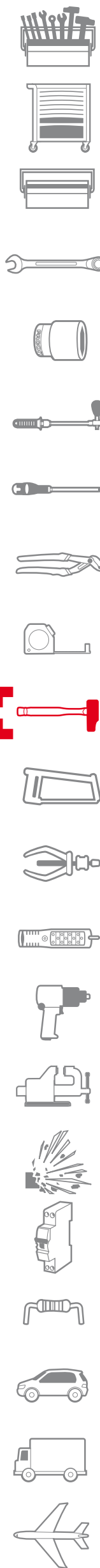

SHEATHED SERIES

IMPACT TOOL SAFETY:

- Check the condition of the tool before use.
- Do not use tools with traces of wear, mushrooming, scaling or cracks.
- Wear eye protection and gloves.



257.G Sheathed automatic centre punch

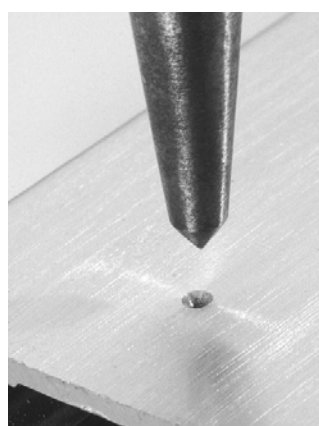

- Simply press the end to release spring impact.
 - Impact adjustable from 15 to 25 kg.
 - Ergonomic Facom handle.
 - Tip hardened to 57 - 60 HRc.
- Weight: 0.175 kg.

263.G - Sheathed chisels

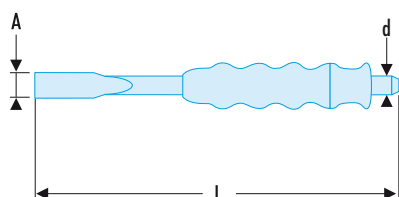

- Engineers chisels.
- Hardness:
 - Tip hardened to 57 - 60 HRc.
 - Head hardened to 36 - 44 HRc.
- Cutting angle: 60°.

Facom	A [mm]	d [mm]	L [mm]	ΔΔ [kg]
263.G19	15	12	190	0,165
263.G20	20	16	200	0,305
263.G22	25	18	220	0,415

Sheathed cape chisels

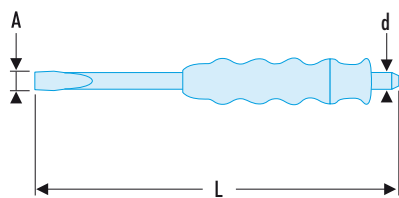

- Hardness:
 - Edge: 57-60 HRc.
 - Impact head: 36- 44 HRc.

Facom	A [mm]	d [mm]	L [mm]	ΔΔ [kg]
265.G18	10	10	180	0,110

263.GJ4 Set of sheathed tools



- Comprising:
 - 3 chisels: 263.G19 - 20 - 22.
 - 1 cape chisel: 265.G18.
- Supplied on cardboard box.
- Weight: 1.005 kg.

MOD.CG1 Drift punch - chisels - sheathed cape chisel module



- Comprising:
 - 249.G 12 - 14 - 16 mm: 3 sheathed drift punches.
 - 263G. 19 - 20 - 22: 3 sheathed chisels.
 - 265.G 18: 1 sheathed cape chisel.
- Heat-formed tray PL.611.
- Weight: 3.000 kg.

Drifts

249 - Standard drift punches

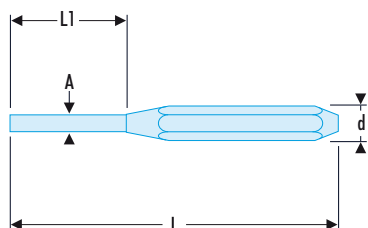

NF E 71-211, DIN 6450, ASME B107.410

- Hexagonal shank, high-strength steel tip, hardened to 53-58 HRc.
- Zinc-plated finish.

≡	A [mm]	d [mm]	L [mm]	L1 [mm]	ΔΔ [kg]
249.2	1,9	8	115	30	0,030
249.3	2,9	8	125	40	0,035
249.4	3,9	10	150	50	0,065
249.5	4,9	10	165	50	0,075
249.6	5,9	12	180	50	0,120
249.8	7,9	12	200	50	0,160
249.10	9,9	16	200	50	0,220

248 - One-piece drift punches

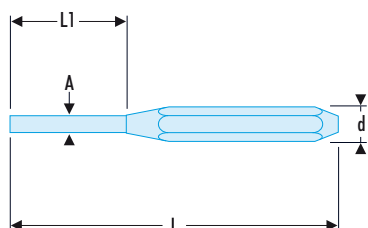

NF E 71-211

- Octagon-shaped, high-strength steel tip, hardened to 53-55 HRc.
- Zinc-plated finish.

≡	A [mm]	d [mm]	L [mm]	L1 [mm]	ΔΔ [kg]
248.2	1,9	8	150	30	0,045
248.3	2,9	8	150	40	0,050
248.4	3,9	10	150	50	0,055
248.5	4,9	10	150	50	0,065
248.6	5,9	10	150	50	0,070
248.8	7,9	12	150	50	0,100
248.10	9,9	12	150	50	0,120

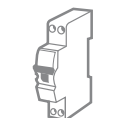

246 - Drift punches for spring pins

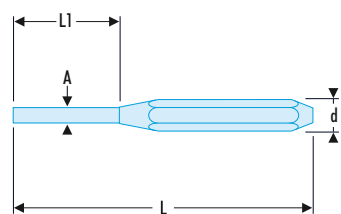

- Octagon-shaped body.
- Zinc-plated finish.
- Shouldered tip accurately centers into split pins.
- Hardened to 53 to 58 HRc guaranteeing perfect absorption of the shockwave.

⇒	A [mm]	d [mm]	L [mm]	L1 [mm]	ΔΔ [kg]
246.2	1,9	8	150	30	0,045
246.3	2,9	8	150	40	0,045
246.4	3,9	10	150	50	0,060
246.5	4,9	10	150	50	0,060
246.6	5,9	10	150	50	0,070
246.8	7,9	12	150	50	0,100

251A - Precision sleeved drift punches

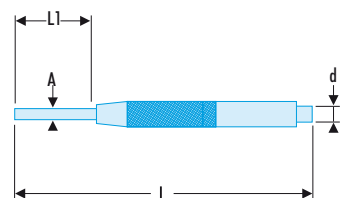
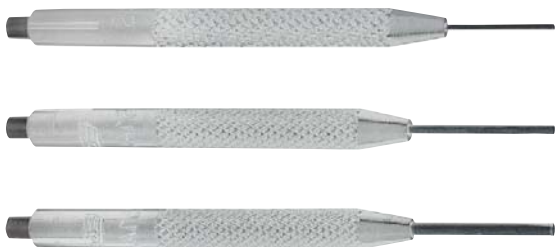

- The centre slides within a guide to prevent distortion, even in smaller sizes.
- Shank hardened to 52 to 57 HRc.
- Zinc-plated body, burnished body.

⇒	A [mm]	d [mm]	L [mm]	L1 [mm]	ΔΔ [kg]
251A.1	0,9	3	70	14	0,005
251A.1,5	1,4	3,5	83	21	0,010
251A.2	1,9	3,5	88	26	0,010
251A.2,5	2,4	4,5	93	22	0,018
251A.3	2,9	4,5	93	22	0,020
251A.3,5	3,4	5,5	96	25	0,025
251A.4	3,9	5,5	96	28	0,030
251A.5	4,9	7	107	33	0,045
251A.6	5,9	9	112	36	0,065

Nail sets

247 - Nail sets

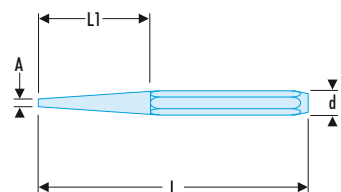

NF E 71-211, DIN 6458, ASME B107.410

- Octagon-shaped body.
- Shank hardened to 54 - 58 HRc.
- Zinc-plated finish.

⇒	A [mm]	d [mm]	L [mm]	L1 [mm]	ΔΔ [kg]
247.2	2	10	120	40	0,060
247.3	3	10	120	40	0,060
247.4	4	10	120	40	0,060
247.5	5	10	120	40	0,065
247.6	6	10	120	40	0,070
247.8	8	12	120	40	0,100

DRIFT PUNCHES

IMPACT TOOL SAFETY:

- Check the condition of the tool before use.
- Do not use tools with traces of wear, mushrooming, scaling or cracks.
- Wear eye protection and gloves.



Drift punches

256 - Precision centre punches

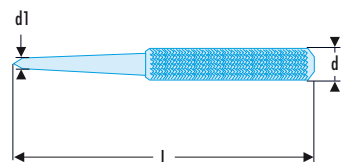

NF E 71-211, DIN 7250, ASME B107.410

- Chrome-vanadium steel forged, hardened to 52 to 58 HRC.
- Presentation: knurled body.
- Zinc-plated finish.

➤	A [mm]	d [mm]	L [mm]	ΔΔ [kg]
256.2,5	2,5	7	100	0,025
256.4	4	8	105	0,035
256.6	6	10	115	0,060
256.8	8	12	130	0,100
256.10	10	14	130	0,135

257A Automatic centre punch

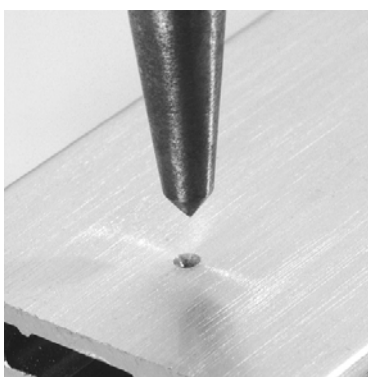

- Simply press the end to release spring impact.
 - Impact adjustable by turning the knurled head.
 - Acceptable load: 11 to 22 kg.
 - Presentation: chrome body, greased tip.
 - Length: 163 mm, body Ø 16 mm, shank Ø 7 mm.
- Weight: 0.135 kg.

Interchangeable tip: 257.07.

Spare tip: 257.10A.

Sets

Impact tools set

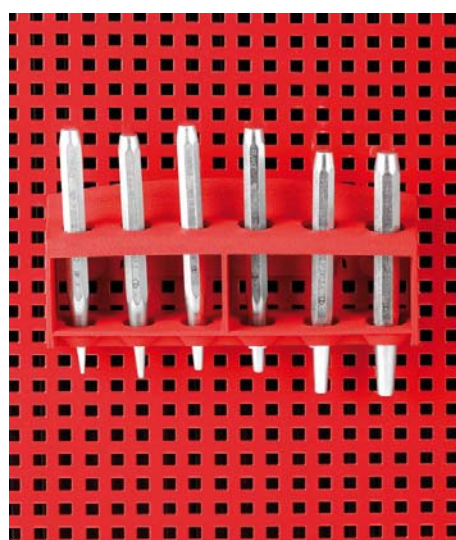

- JS Presentation on holder.
- JT Presentation as roll sets.
- For 249.JT7: roll set N.38A-7B.
- For 248.JT7: roll set N.38A-7B.
- For 251A.JT9: roll set N.38A-9C.
- For 247.265JT10: roll set N.38A-10B.

➤	Dimension [mm]	Content set	Organiser for	ΔΔ [kg]
249.JS7	120x195x45	249.2-3-4-5-6-8-10	CKS.103	0,868
249.JT7	230x120	249.2-3-4-5-6-8-10	N.38A-7B	0,755
248.JS6	120x190x45	248.2-3-4-5-6-8	CKS.103	0,588
248.JT7	265 x 120	248.2-3-4-5-6-8-10	N.38A-7B	0,695
246.JS6	120x190x45	246.2-3-4-5-6-8	CKS.103	0,593
246.JT6	200x165	246.2-3-4-5-6-8	N.38A-6C	0,545
251A.JS9	120x115x45	251A.1-1.5-2-2.5-3-3.5-4-5-6	CKS.103	0,354
251A.JT9	180 x 120	251A.1-1.5-2-2.5-3-3.5-4-5-6	N.38A-9C	0,260
247.249JS12	120x180x47	247.2-3-4-5-6-8 / 249.2-3-4-5-6-8	CKS.103	1,076
247.265JT10	180x120 / 240x60	247.3-4-5 / 256.4-6 / 249.3-4-5 / 263.20 / 265.18	N.38A-10B	1,155

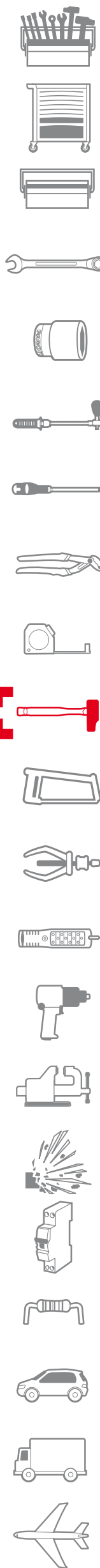

Flat chisels - Cape chisels

263 - Slim chisels

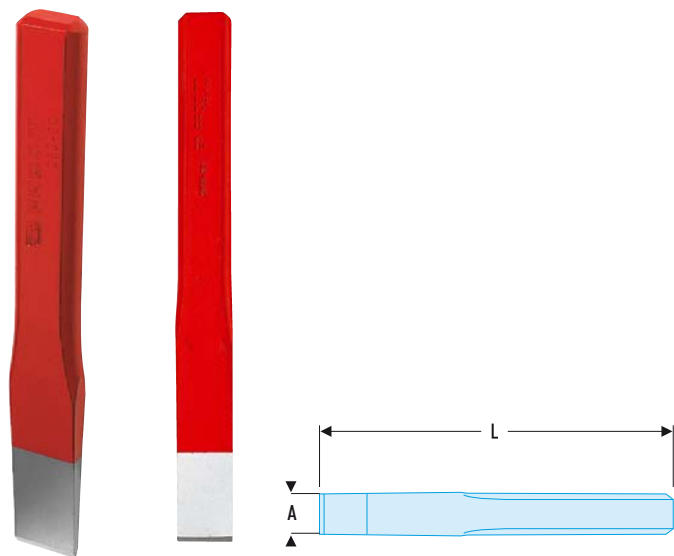

- Constant-profile cape chisel
- Chrome vanadium forged steel; differentiated heat treatment - edge 54 - 58 HRC - impact head 38 - 46 HRC to prevent head effect.
- Edge resharpening with grinder.
- Presentation: lacquered.

➤	A [mm]	L [mm]	ΔΔ [kg]
263.15	21	150	0,200
263.18	21	180	0,250
263.20	24	200	0,350
263.22	24	220	0,380
263.25	27	250	0,500
263.30	27	300	0,610

263P - Chisels with guard



- Chisels with guard, diameter: 85 mm.
- Chrome vanadium forged steel; differentiated heat treatment: edge 54 - 58 HRC - impact head 38 - 46 HRC to prevent head effect.
- Edge resharpening with grinder.
- Presentation: lacquered.

➤	A [mm]	L [mm]	ΔΔ [kg]
263.P25	27	250	0,610
263.P30	27	300	0,710

265 - Cape chisels



- Constant-profile cape chisels.
- Chrome vanadium forged steel; differentiated heat treatment: edge 54 - 58 HRC - impact head 38 - 46 HRC to prevent head effect.
- Edge resharpening with grinder.
- Presentation: lacquered.

➤	A [mm]	L [mm]	ΔΔ [kg]
265.18	8	180	0,240
265.20	10	200	0,310
265.22	10	220	0,370

259 Slim-profile chisels

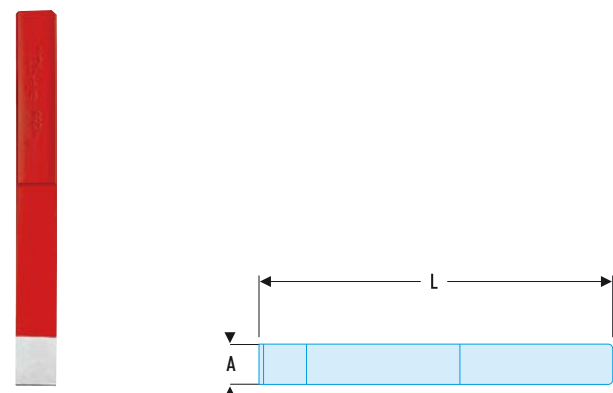

- Slim profile chisel.
 - Chrome vanadium forged steel, treated 57 HRC on edge and 40 HRC on impact head.
 - Blade width: 26 mm.
 - Length: 235 mm.
 - Presentation: lacquered.
- Weight: 240 g.

259.P Slim-profile chisel with guard



- Chisel with guard, diameter: 85 mm.
- Chrome vanadium forged steel, treated 57 HRc on edge and 40 HRc on impact head.
- Blade width: 26 mm.
- Length: 235 mm.
- Presentation: lacquered.
- Weight: 400 g.

260.P Wide chisel with guard



- Chisel with guard, diameter: 85 mm.
- Chrome vanadium forged steel and hardened to 57 HRc on edge.
- Edge resharpening with grinder.
- Head hardened to prevent head effect.
- Blade width: 60 mm.
- Length: 250 mm.
- Presentation: lacquered.
- Weight: 630 g.

Set of chisels and cape chisels on holder



🔪	Dimension [mm]	Content set	Organiser for	ΔΔ [kg]
263.265JS5	255 x 180 x 30	263.15-20-25 265.18-22	CKS.81A	1,850

262A - Ribbed chisels, round head

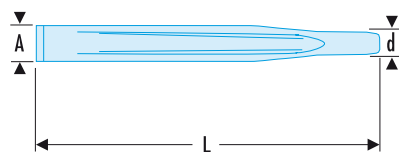

- Forged chisels with rounded edges for better handling.
- Cylinder-shaped head for safer impact.
- Cutting edge hardness: 57 to 59 HRc.
- Cutting edge angle: 60°.
- Presentation: zinc-plated finish.

🔪	A [mm]	d [mm]	L [mm]	ΔΔ [kg]
262A.15	21	16	150	0,170
262A.18	24	18	180	0,250
262A.20	26	18	200	0,340
262A.25	29	21	260	0,500

Set of ribbed chisels on holder



🔪	Dimension [mm]	Content set	Organiser for	ΔΔ [kg]
262A.JS4	180 x 30 x 250	262A.15-18-20-25	CKS.80B	1,440

