



PERSONAL SAFETY EQUIPMENT

716



Personal safety equipment..... 716

MISCELLANEOUS MAINTENANCE

718



Miscellaneous maintenance..... 718

PIPEWORK TOOLS

720



Pipe wrenches..... 720
 Chain wrenches, strap wrenches 721
 Benders..... 722
 Iron-stainless steel pipe cutters 723
 Copper-pipe cutter..... 724
 Plastic-pipe cutter 724
 Deburring - chamfering 725
 Clamp tools 725

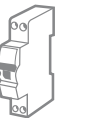
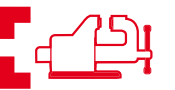
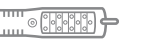

RIVETING

727



- Manual riveting pliers 727
- Air riveting pliers..... 728
- Sets and modules..... 729

LUBRICATION

730



- Lubrication tools..... 730

VICES - PRESSES - CLAMPS

732



- Vices 732
- Assembly presses 734
- Clamps..... 735

WHY WEAR GLOVES?

- ① To protect against mechanical hazards: abrasion, cut, tear and perforation resistant gloves: (leather gloves BC.109VSE and BC.110VSE).
- ② To protect against chemical hazards: (latex gloves BC.80VSE and BC.91VSE)
- ③ To protect against electrical hazards: 500 to 1,000 volts (insulated gloves BC.VSE).



BC.VSE - Insulated gloves



NF EN 60903, EN 60903, DIN EN 60903

- Natural latex gloves, AZM classification:
 - Resistance to acid: A.
 - Resistance to ozone: Z.
 - High mechanical strength: M.
- Length: 360 mm.
- Supplied in anti-UV opaque bag.
- Weight: 150 g

🚚	Class	Size [mm]	E [mm]	Voltage\Volt
BC.80VSE	00	9 (B)	0,5	500
BC.81VSE	00	10 (C)	0,5	500
BC.90VSE	0	9 (B)	1,0	1000
BC.91VSE	0	10 (C)	1,0	1000

BC.VSE - Safety overgloves



NF EN 60903, EN 60903, DIN EN 60903

- Silicon coated leather gloves protecting from mechanical risks.
- Used to protect latex insulated gloves.
- Physical and mechanical grade as per standard EN 388: 2, 1, 2, 1.
 - Abrasion: 2.
 - Cuts: 1.
 - Tears: 2.
 - Perforation: 1.

🚚	Size [mm]	ΔΔ [g]
BC.109VSE	9 (B)	160
BC.110VSE	10 (C)	160

BC.VSE - Insulated mats



NF C 18-421

- Rubber mat for insulation by cladding grounds.
- Thickness: 3.2 mm.
- Hardness: 60 DIDC.
- Dimensions:
 - BC.20VSE: 1 x 0,6 m.
 - BC.21VSE: 1 x 1 m.

	ΔΔ [kg]
BC.20VSE	2,500
BC.21VSE	4,200

BC.1J20 Respiratory protection mask



NF EN 149, DIN EN 149,

- Set of 20 dust masks.
 - Protection indispensable against fine dust (sanding, etc).
- Weight: 226 g.

BC.5 Wrap-around protection glasses



NF EN 166, NF EN 168, DIN EN 166, DIN EN 168.

- Protection against projections of any nature.
 - Indispensable for grinding, chiseling, etc.
 - "Shell" shape able to contain glasses.
- Weight: 82 g.

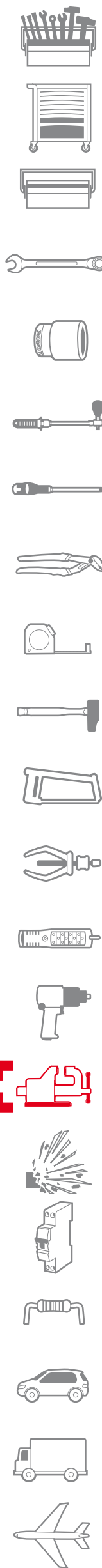

■ E.2005 Heat gun



- Electronic temperature control 60 to 600°C.
- Force: 2000 W.
- Power supply: 220 V/50 Hz.
- Air flow rate (2 speeds): 300 l/min and 500 l/min.
- VDE approved.
- Supplied with 2 nozzles: E.2002B1 - E.2002B3.
- Dimensions (L. x W. x H.): 330 x 80 x 72 mm.
- Weight: 770 g.

- Distribution nozzle, dim. (L. x h x d): 75 x 75 x 33.7 mm; weight 58 g: E.2002B1.
- Cross-flow nozzle, dim. (L. x h x d): 75 x 80 x 33.7 mm; weight 56 g: E.2002B2.
- Reflector nozzle, dim. (L. x h x d): 33 x 60 x 33.7 mm; weight 32 g: E.2002B3.
- Concentrator nozzle, dim. (L. x h x d): 20 x 52 x 33.7 mm; weight 30 g: E.2002B4.

■ D.3 - Pry bars

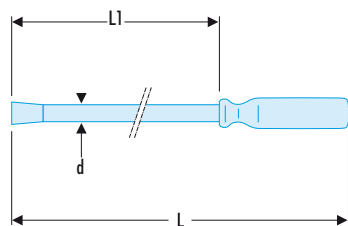

- Numerous uses: suspension, gear train, bodywork, etc.
- Sturdy blade minimising lever spring effect.

■	d ["]	L [mm]	L1 [mm]	ΔΔ [kg]
D.3-7	3/8	292	165	0,275
D.3-12	3/8	422	305	0,345
D.3-18	1/2	635	460	0,810
D.3-24	1/2	787	610	1,030
D.3-30	5/8	915	740	1,710

■ D.3J3 Set of 3 pry bars



- Numerous uses: suspension, gear train, bodywork, etc.
- Sturdy blade minimising lever spring effect.
- Set comprising: D.3-7 - D.3-12 - D.3-18.
- Supplied in thermoformed tray.
- Dimensions (L. x W. x H.): 670 x 145 x 40 mm.
- Weight: 1.648 kg.

1260 - Wrecking bars

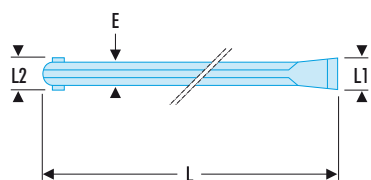

- Forged, one flat end and one nail-claw, hardened to 45 HRc.
- Presentation: red lacquered, polished, varnished ends.

🔪	E [mm]	L [mm]	L1 [mm]	L2 [mm]	ΔΔ [kg]
1260.50	18	495	33	28	0,920
1260.70	23	710	39	35	1,140

268 - Round crowbars with crook beak

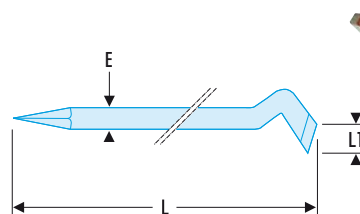

- Forged, one spindle end and one wide and slim pallet end, hardened to 45 HRc.
- Presentation: red lacquered, polished, varnished ends.

🔪	E [mm]	L [mm]	L1 [mm]	ΔΔ [kg]
268.3	16	450	32	0,670
268.4	20	790	32	1,970
269	18	400	27	0,590

270A.MA Steel wire brush



- Dimensions: 280 x 34 x 60 mm.
- Weight: 150 g.

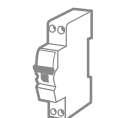
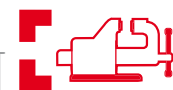

Pipework wrenches

131A - Steel Stillson models

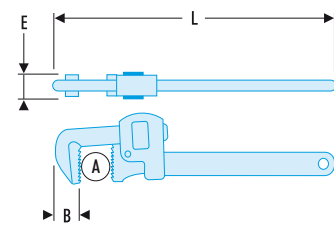

- Capacity: 0 to 102 mm; 0 to 3"1/2.
- Very robust wrench, head hardened to 55 HRc.
- Accurate approach thanks to fine machining of the threads and button, good grip.

➤	A maxi [mm]	A maxi ["]	B [mm]	E [mm]	L [mm]	L ["]	ΔΔ [kg]
131A.8	27	3/4	19,5	12,5	200	8	0,280
131A.10	34	1	25,0	16,0	250	10	0,600
131A.14	49	1 1/2	29,5	21,0	350	14	1,060
131A.18	60	2	32,0	24,0	450	18	1,800
131A.24	76	2'	41,5	27,5	600	24	3,000
131A.36	102	3'1/2	49,5	30,5	900	36	6,000

134A - Cast-iron American model pipe wrenches

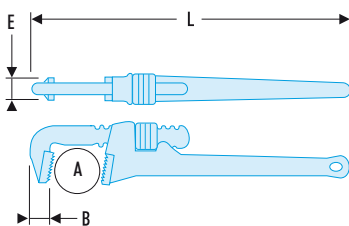

- Capacity: 0 to 140 mm; 0 to 5".
- Cast iron body.
- Interchangeable fixed jaw hardened to 55 HRc.
- Forged steel mobile jaw.

➤	A maxi [mm]	A maxi ["]	B [mm]	E [mm]	L [mm]	L ["]	ΔΔ [kg]
134A.8	35	1	15	14,5	200	8	0,400
134A.10	54	1 1/2	20	17,5	250	10	0,780
134A.14	60	2	26	21,5	350	14	1,500
134A.18	76	2 1/2	29	26,0	450	18	2,400
134A.24	102	3 1/2	35	29,5	610	24	4,000
134A.36	140	5	35,5	43,0	920	36	9,000

135A - Light alloy 90° offset American model pipe wrenches

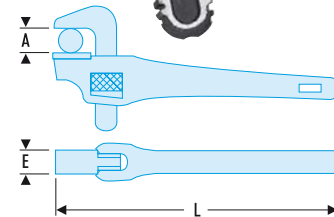

- Capacity: 0 to 76 mm; 0 to 2"1/2.
- Light alloy body.
- Jaws in steel hardened to 55 HRc.

➤	A maxi [mm]	A maxi ["]	E [mm]	L [mm]	L ["]	ΔΔ [kg]
135A.14	49	1 1/2	34	350	14	0,940
135A.18	60	2	39	450	39	1,480
135A.24	76	2 1/2	47	600	47	2,450

133A - Light alloy 90° offset American model pipe wrenches

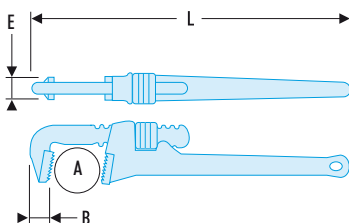

- Capacity: 0 to 140 mm; 0 to 5".
- Performance equivalent to model 134A.

➤	A maxi [mm]	A maxi ["]	B [mm]	E [mm]	L [mm]	L ["]	ΔΔ [kg]
133A.14	60	2	26	21,5	350	14	1,000
133A.18	76	2 1/2	30	26,0	450	18	1,560
133A.24	90	3	34	29,5	600	24	2,460
133A.36	140	5	44	32,0	900	36	5,180

120A - "Swedish" model wrench - 45°

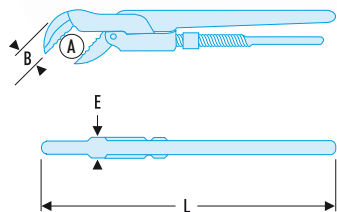

DIN 5234

- Capacity: 10 to 60 mm; 3/8" to 2".
- High-quality forged steel body.
- Special jaw design grips pipe at three points.

➤	A maxi [mm]	A maxi ["]	B [mm]	E [mm]	L [mm]	ΔΔ [kg]
120A.1'	34	1	22	10	345	0,840
120A.1'1/2	49	1'1/2	26	13	450	1,450
120A.2'	60	2	39	17	600	2,400

121A - "Swedish" model wrench - "S" jaws - 45°

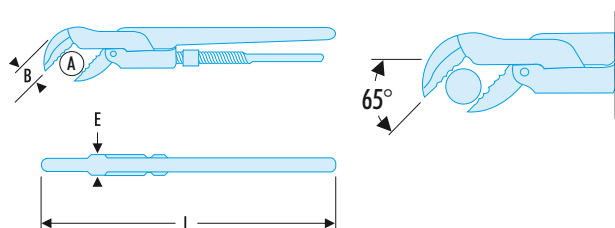

DIN 5234

- Capacity: 10 to 60 mm; 3/8" to 2".
- High-quality forged steel body.
- Special jaw design grips pipe at three points.

➤	A maxi [mm]	A maxi ["]	B [mm]	E [mm]	L [mm]	ΔΔ [kg]
121A.1'	34	1	22	14	345	0,850
121A.1'1/2	49	1'1/2	26	19	450	1,550
121A.2'	60	2	39	21	600	2,300

Chain and strap wrenches

136A - Double effect chain wrench

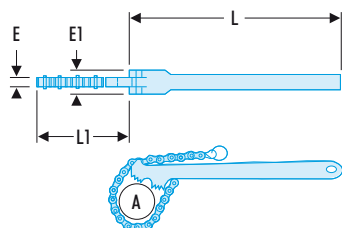

- Capacity: 60 to 140 mm.
- Hardened steel chain and body.
- Twin serrations allow rotation in either direction.
- 136.D2: spare chain for model 136A.2.
- 136A.C4: spare chain for model 136B.4 and 136A.4.

➤	A [mm]	A ["]	B [mm]	E [mm]	L [mm]	L1 [mm]	ΔΔ [kg]
136A.2	60 - 114	2 - 4'	20	7	360	460 - 18,5'	1,040
136B.4	90 - 140	3 - 5'	30	10	600	600 - 24'	3,100

137A - High power chain wrench

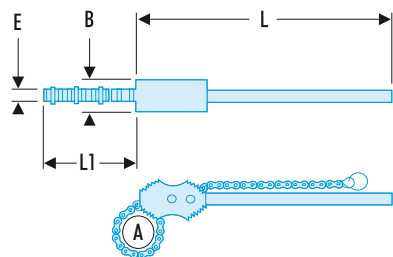

- Capacity: 50 to 180 mm.
- Forged steel handle.
- Serration hardened to 48 HRC.
- Jaws treated against corrosion.
- "Ratchet" system in both directions for easier trench work.
- 137A.C2'1/2: spare chain for model 137A.2'1/2.
- 137A.C4': spare chain for high power model 137A.4'.
- 137A.C6': spare chain for high power model 137A.6'.

➤	A [mm]	A ["]	E [mm]	L [mm]	L1 [mm]	ΔΔ [kg]
137A.2'1/2	50 - 90	2 - 3'9/16	20	550	415 - 16"	4,500
137A.4'	60 - 130	2'3/8 - 5'1/8	20	910	560 - 24"	8,000
137A.6'	80 - 180	3'3/16 - 7'1/8	32	690	690 - 27"	10,500

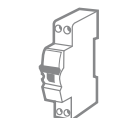

138A - Nylon strap wrenches

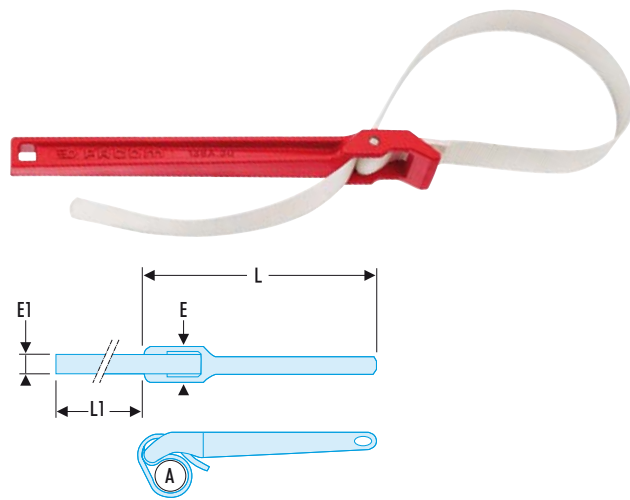

- Capacity: 0 to 165 mm.
- Body in aluminum alloy.
- High strength nylon strap.

➤	A [mm]	A ["]	A maxi [mm]	E [mm]	E1 [mm]	L [mm]	L1 [mm]	ΔΔ [g]
138A.17	60	2	60	42	30	550	450	280
138A.30	125	4	125	42	30	910	750	290
138A.48	165	6	165	42	30	1065	1500	310

138.S17 Spare strap



- To be used with the nylon strap wrench
- Length 1200 mm (48").
- 138.S17: spare strap for 138A.17.
- 138.S30: spare strap for 138A.30.
- 138.S48: spare strap for 138A.48.

Pipe benders

344A - Bending pliers

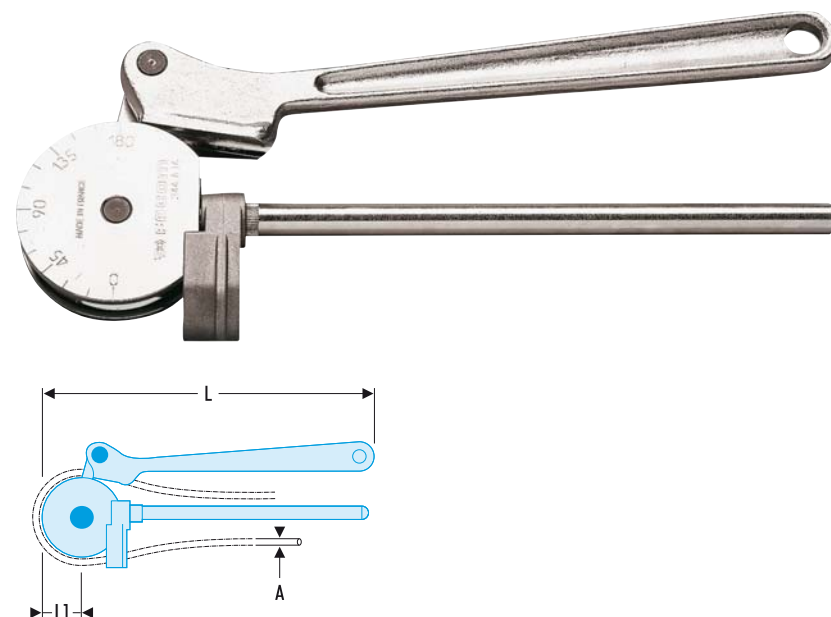

- Capacity: 8 to 18 mm.
- To shape pipes in cold drawn or annealed copper.
- Easy use on the work place without particular installation.
- Bending angle measurement (0° - 180°).
- Can be carried on a tool box.
- Made in forged and machined steel.

➤	A [mm]	A ["]	L [mm]	L1 [mm]	ΔΔ [kg]
344A.8	8	5/16	208	14	0,340
344A.10	10	-	245	23	0,700
344A.12	12	-	270	30	0,900
344A.14	14	-	352	42	1,800
344A.15	15	-	352	42	1,900
344A.16	16	5/8	380	54	2,640
344A.18	18	-	380	55	2,900

Iron-stainless steel pipe cutter

▣ 338B.1 Iron pipe cutter



- Accurate guiding for right angle cutting.
- Dimensions: 130 x 34 mm.
- Min length 255 mm - max length 310 mm.
- Spread: 10 to 42 mm, 1/8 to 1" 1/8.
- Weight: 1.480 kg.

- 38A.F5: Set of 5 spare rollers.

▣ 337A.2 Stainless steel pipe cutter



- Accurate guiding for right angle cutting.
- Fitted with a wheel cutting stainless steel pipes.
- Dimensions: 160 x 34 mm.
- Spread: 21 to 60 mm, 1/2 to 2".
- Min length 310 mm - max length 400 mm.
- Weight: 2.700 kg.

- 337.F5: Set of 5 spare wheels.

▣ 334.35NX "High precision" stainless steel pipe cutter



- Fast adjustment button, covered in soft material for enhanced comfort.
- 4 rollers for perfect pipe guiding.
- Folding deburrer.
- Supplied with spare wheel.
- Very easy wheel changing without tool.
- Cuts stainless steel pipes from 3 to 35mm.
- Weight: 0.440 kg.

- 334.M5: set of 5 spare wheels.

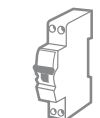

Copper pipe cutter

334B.35 "High precision" copper pipe cutter



- Comfortable fast advance knob.
- Optimum pipe guiding. Cut to 90°.
- Grooves for flush flange cutting.
- Folding rotary deburrer.
- Built-in spare wheel.
- Cutting diameter: 3 - 35 mm; 1/4 - 1" 1/4.
- Weight: 0.450 kg.
- 238A.M5: Set of 5 spare wheels.

238 - Copper-pipe mini-cutter

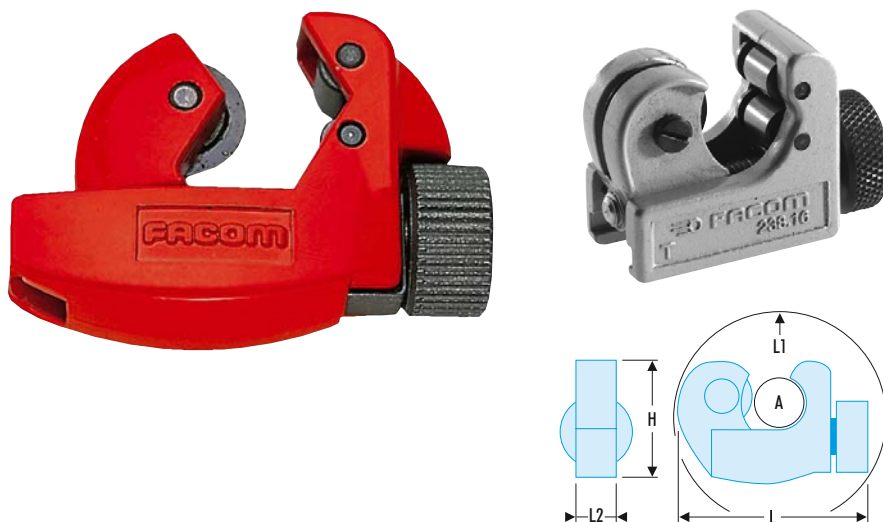

- 238B.16, grey, 238.28, red.
- Very compact.
- Can be used in situ.
- Minimal working radius.
- Set of 5 spare wheels:
 - 238B.16M5 for model 238B.16.
 - 238A.M5 for model 238.28.
 - 238.M5 for old model 238.16.

	A [mm]	A ["]	H [mm]	L [mm]	L1 [mm]	L2 [mm]	ΔΔ [g]
238B.16	3 - 16	1/8 - 5/8	35	55	38	21	120
238.28	6 - 28	1/4 - 11/8	50	80	50	26	205

Plastic pipe cutter

Ratchet pipe cutter

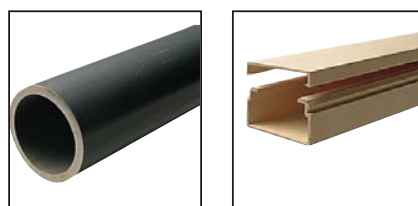

- Pipe cutter for PVC pipes up to 25 mm diameter: 4 x 2.5 mm max; 4 x 3/32 s. inch.
- Fast and neat cutting.
- Automatic jaw opening.
- Ratchet advance with non-return mechanism.
- Fast advance for approach on small diameters.
- Chamfering tool built into the handle.

	A maxi [mm]	A maxi ["]	ΔΔ [g]
335.25	25	1	165

335B.40 Large diameter ratchet pipe cutter



- Ratchet pipe cutter for PVC pipes up to 40 mm diameter.
- Easy cutting with the ratchet system.
- Blade returns to the rest position by opening the branches.
- Weight: 0.600 kg.

Plastic pipe cutter



- Ratchet pipe cutter for plastic pipes up to 63 mm diameter.
- Patented "V" profile blade for perfect cut, even on the smallest pipes.
- Stainless steel cutting blade: sturdy and long life cut.
- Can cut multiple strand flexible cables up to 5 x 2.5 mm².

	A maxi [mm]	A maxi ["]	ΔΔ [kg]
335.63	63	2 1/2	1,100

Deburring - Chamfering

325 Deburring-chamfering case



- Selection of tools necessary for deburring and chamfering pipes in steel, aluminum, copper, brass, plastic.
- Blade holder working length: 110 mm.
- Case dimensions: 200 x 110 x 40 mm. Weight: 0.425 kg.
- 325.01 One-piece blade deburrer for steel and aluminum.
- 325.02 Tool holder handle.
- 325.03 Blade holder extension: for blades diameter 2.6 and 3.2 mm.
- 325.05 Triangular scraper, sharpening at both ends.
- 325.L1J10 Set of 10 HSS steel blades for steel and aluminum; length 23 mm; diameter 2.6 mm.
- 325.L10J10 Set of 10 HSS steel blades for steel and aluminum; length 23 mm; diameter 3.5 mm.
- 325.L35J10 Set of 10 HSS "heavy duty" steel blades for steel and aluminum; length 47 mm; diameter 3.2 mm.

Collar tools

347 Set for S.A.E, DIN, S.A.E./DIN flanges



- Capacity: copper and steel pipe Ø 4.75 to 12 mm?; 3/16" to 1/2".
- Thickness: 0.7 to 1 mm.
- The press can be locked in a vice for more safety.
- Fast and effortless shaping.
- The set includes 11 punches and 10 dies.
- Operator instructions allow selection according to the type of flanges to produce.
- Metal sheet case: 396 x 224 x 82 mm. Weight: 7.900 kg.

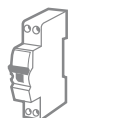
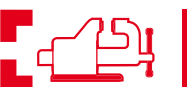
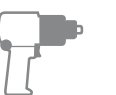

▣ 239 "Refrigeration" flanging tool, metric die 6 mm - 14 mm



- Capacity: pipes diam. 6 to 14 mm.
 - Allows to produce flanges tapered at 45°, at the end of copper pipes without annealing the metal.
 - BP.115 dimensions: 332 x 143 x 67 mm.
 - Weight: 1.520 kg.
- 239.MU: Inch dies: pipes diam. from 3/16" to 5/8".

▣ 240.M "Refrigeration" metric kit



- Caliper and die for pipes diameter: 6 - 8 - 10 - 12 - 14 mm.
- 334.32 pipe cutter.
- Supplied in plastic box.
- BP.115 dimensions: 332 x 143 x 67 mm.
- Weight: 1.820 kg.

▣ 242 "Refrigeration" metric-inch kit



- Caliper.
- Die for pipes diameter: 6 - 8 - 10 - 12 - 14 mm.
- Die for pipes diameter: 3/16" - 1/4" - 5/16" - 3/8" - 7/16" - 1/2" - 5/8".
- 334.32 pipe cutter.
- Supplied in plastic box dimensions: 350 x 125 x 40 mm.
- Weight: 2.400 kg.

Riveting pliers

■ Ergonomic riveting pliers

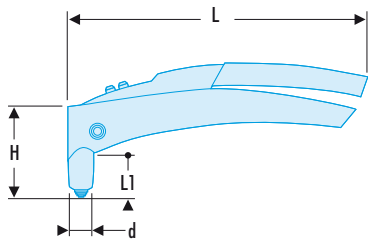

- Capacity:
 - Diameter 5 mm alu rivets.
 - Diameter 4 mm steel rivets.
- Grips shaped for optimum comfort.
- Return-spring to closed position prevents loss of rivet.
- Cushioning system when pin snaps.
- Supplied with 3 nosepieces for diameters 3 to 3.2 mm - 4 mm - 4.8 to 5 mm.
- Knurled nosepieces for hand-fitting.

➤	d [mm]	H [mm]	L [mm]	L1 [mm]	ΔΔ [g]
Y.105B	22	85	270	40	632

■ Riveting pliers

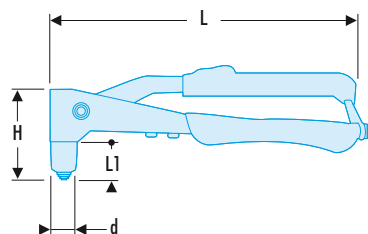

- capacity:
 - Aluminum rivets diameter 3 - 3.2 - 4 - 4.8 - 5 mm.
 - Steel rivets diameter 3 - 3.2 - 4 mm.
- Empty branches opening spring.
- 3 nosepieces with keys for diameters 3 to 3.2 mm - 4 mm - 4.8 to 5 mm.

➤	d [mm]	H [mm]	L [mm]	L1 [mm]	ΔΔ [g]
Y.103B	22	84	250	26	632

■ Two-hand riveter

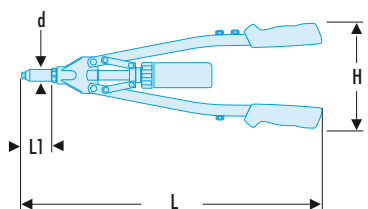

- Capacity:
 - Diameter 6.4 mm alu rivets.
 - Diameter 6 mm steel rivets.
- Absorbers cushion impact when pin snaps.
- Supplied with 4 nosepieces diameter 4 - 5 - 6 - 6.4 mm and spent-nail holder.

➤	d [mm]	H [mm]	L [mm]	L1 [mm]	ΔΔ [kg]
Y.116B	22	164	526	66	1,900

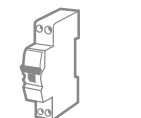
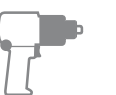

▣ "Expander" riveting pliers

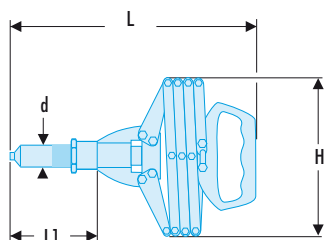

- Capacity:
 - Diameter 6.4 mm alu rivets.
 - Diameter 5 mm steel rivets.
- Model suited to heavy duty, particularly in worksites.
- Supplied with 5 nosepieces: diameters 3 to 3.2 mm - 4 mm - 4.8 to 5 mm - 6 mm - 6.4 mm.

➤	d [mm]	H [mm]	L [mm]	L1 [mm]	ΔΔ [kg]
Y.113B	25	184	310	90	2,150

▣ Blind-nut pliers

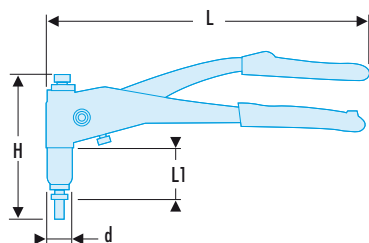

- Capacity: M6 steel; M5 stainless steel.
- Supplied with 3 steel nuts M4 - M5 - M6.
- Very comfortable pliers as can be used with both hands.

➤	d [mm]	H [mm]	L [mm]	L1 [mm]	ΔΔ [kg]
Y.107	25	140	335	50	1,170

▣ Pneumatic riveter



- Light and well balanced machine in aluminum alloy.
- For 3.2 - 4 and 4.8 mm rivets.
- Traction strength 9.4 kN.
- Fast nose removal.
- Fast claw holder removal.
- Low activation force.
- 2-finger trigger.
- Orientable air exhaust.
- Tool travel 18 mm.
- Working pressure: 6.2 bars.

➤	d [mm]	d1 [mm]	H [mm]	L [mm]	L1 [mm]	ΔΔ [kg]
Y.135F	88	20,6	304	259	79	1,310

Cases and kits

Y.RIV1 Maintenance kit for multi-thickness aluminum rivets



- Comprising:
 - Y.105B: riveter.
 - Selection of rivets diameter 4 to 4.8 mm with standard head, 4.8 mm with wide head, in popular sizes for joint thickness 1.3 to 13 mm (approx. 450 rivets).
 - Partitioned case with contents list.
 - Case dimensions: 360 x 300 x 60 mm.
 - Weight: 2.700 kg.

Y.RIV3 Maintenance kit for aluminum rivets



- Comprising:
 - Y.105B: riveter.
 - Selection of aluminum rivets with standard head 4 x 8 - 4 x 10 - 4.8 x 8 - 4.8 x 10 mm and with wide head 4 x 8 et 4 x 10 mm (approx. 600 rivets).
 - Case dimensions: 360 x 300 x 60 mm.
 - Weight: 2.350 kg.

Y.M46 Blind-nut kit



- Comprising:
 - Y.107: blind-nut riveter.
 - Selection of steel nuts M4 - M5 - M6, in popular sizes for joint thickness 0.3 to 3 mm (approx. 100 nuts).
 - Partitioned case with contents list and instructions: 360 x 300 x 60 mm.
 - Weight: 2.500 kg.

MOD.Y105 Riveting module



- Y.105B: riveter.
- 600 alu rivets.
- Standard head: 4 x 8 - 4 x 10 - 4.8 x 8 - 4.8 x 10.
- Black lacquered standard head: 4 x 8 - 4 x 10.
- Heat-formed tray PL.377.
- Weight: 1.984 kg.

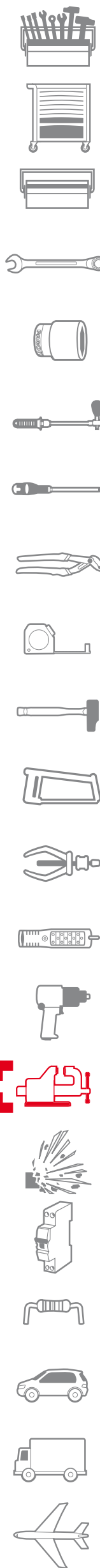

▣ 376A Manual oil syringe



- Capacity: 500 cm³.
- galvanised steel body.
- Supplied with: 376A.1 straight angled tube.
- Length: 420 mm.
- Weight: 0.830 kg.

▣ 378A Lever-operated grease gun



- Grease cartridge.
- Pressure: 400 bar. Air bleed facility.
- Use with cartridge or bulk grease.
- Capacity 500 cm³, i.e. 400 g grease.
- Hose compliant with DIN 1283 standard (static and burst pressure).
- Hose built in rubber approved by DIN 20024 standard.
- Hose diameter: 13.1 mm.
- Hose radius of curvature: 90 mm.
- Length: 370 mm excluding hose.
- Weight: 1.356 kg.

▣ 378.2 Flexible nose for grease pump 378A



- Length 300 mm.
- Weight: 0.100 kg.

▣ 377A Small grease pump

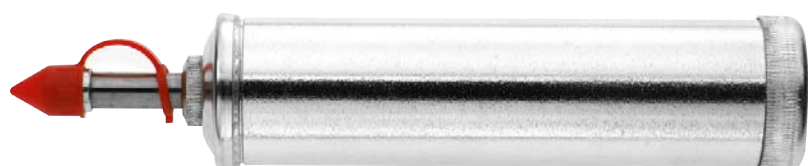

- DIN 1282**
- Nickel-plated body.
 - Supplied with 1 lub type tip and 1 hydraulic type tip.
 - Spread: 150 cm³.
 - Pressure: 200 bar.
 - Length: 345 mm
 - Diameter: 43 mm.
 - Weight: 0.410 kg.

▣ 379A Pneumatic grease gun



DIN 1284

- Capacity 500 cm³, i.e. 400 g grease; flow 1 cm³ per strike.
 - Air pressure 2 to 8 bar (6 bar recommended).
 - Supply fitting diameter 8 mm.
 - Filling with cartridge or bulk grease.
 - Length: 179 mm; height: 380 mm.
 - Presentation: Aluminum body.
 - Supplied with straight angled spout and tip.
- Weight: 1.700 kg.

▣ 380 Set of greasing tips



- Selection of rigid spouts, flexible spouts and fasteners for all types of current greasers.
 - Adaptable to models 378A and 379A.
 - Case dimensions: 310 x 110 x 55 mm.
- Weight: 0.425 kg.

▣ 373 - Simple-action oil cans



- Pumped delivery. Steel body.
- Spout length: 130 mm.
- 3 capacities: 250, 350 and 500 cm³.

⇒	d [mm]	L [mm]	Oil Capacity [cm ³]	ΔΔ [g]
373.25	73	130	250	210
373.35	84	130	350	236
373.50	84	130	500	277

▣ 374A.20 Double-action oil can



- Fitted with a double pump.
- Use in all positions, drop dosage.
- Volume: 200 ml.
- Presentation: Zinc body, impact resistant.
- Dimensions (H. x L. x D.): 271 x 117 x 61 mm.

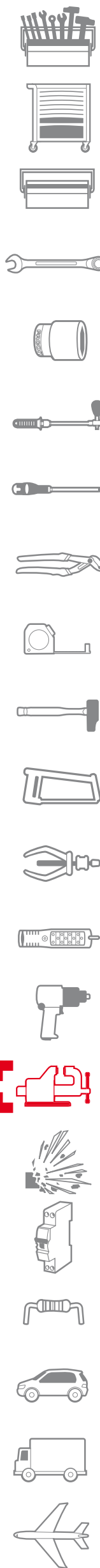

Vices

1222 - Worksite-maintenance 360° swivel vices

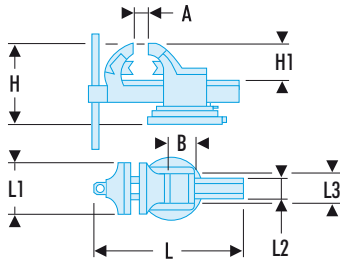

- Vices in spheroid graphite cast iron, tensile strength 700 N/mm² minimum.
- Wide bearing base of the prism guide/mobile jaw: lack of guide flexion, vice operation preserved even under heavy loads.
- Interchangeable parallel jaws. High wear resistance, hardness 48/53 HRc.
- Removable V-shaped jaws for tightening the pipes. Hardness 40/46 HRc.
- Adjustment system by 2 complex gap compensation screws.
- Burnished control bar.

➤	A maxi [mm]	B [mm]	H [mm]	H1 [mm]	L [mm]	L1 [mm]	L2 [mm]	L3 [mm]	ΔΔ [kg]
1222.100	125	48	140	66	325	100	68	41,5	7,240
1222.125	150	60	172	82	402	125	84	51,5	13,800
1222.150	200	70	201	99	492	150	96	58,5	21,850
1222.175	235	80	237	118	551	175	110	67,5	33,350

1222.E - Worksite-maintenance fixed vices

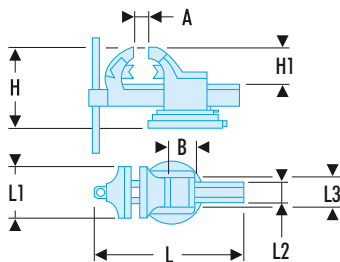
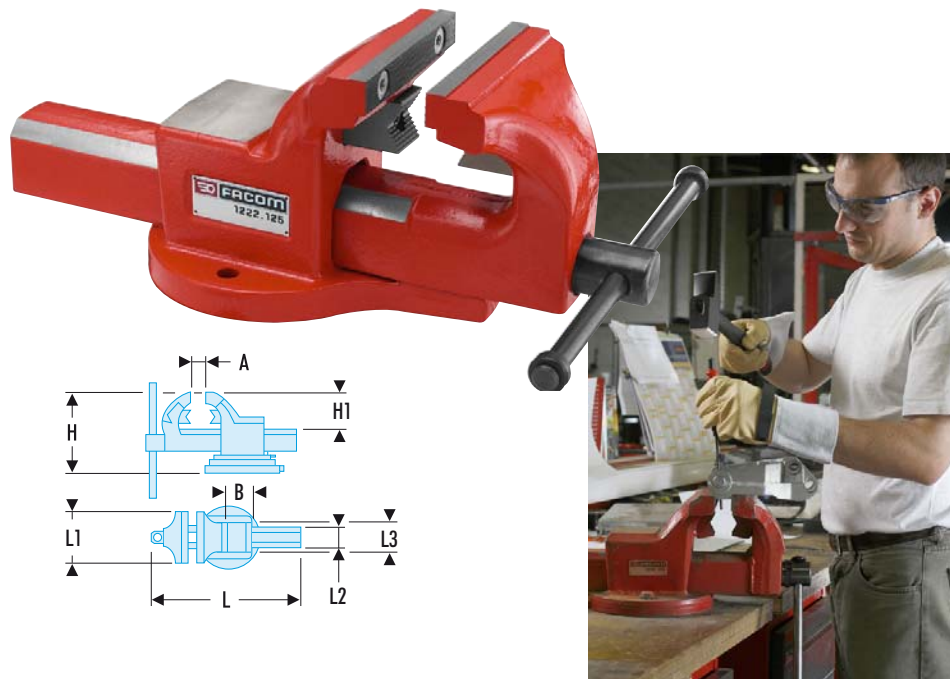

- Characteristics identical to model 1222, but non swiveling.

➤	H [mm]	ΔΔ [kg]
1222.100E	122	6,300
1222.125E	153	12,700
1222.150E	182	20,450
1222.175E	211	30,700

1223 - Swivel adjuster vices

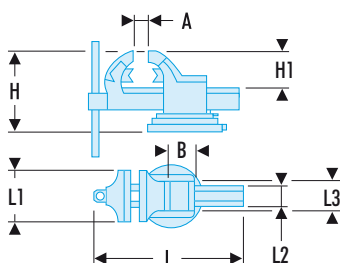
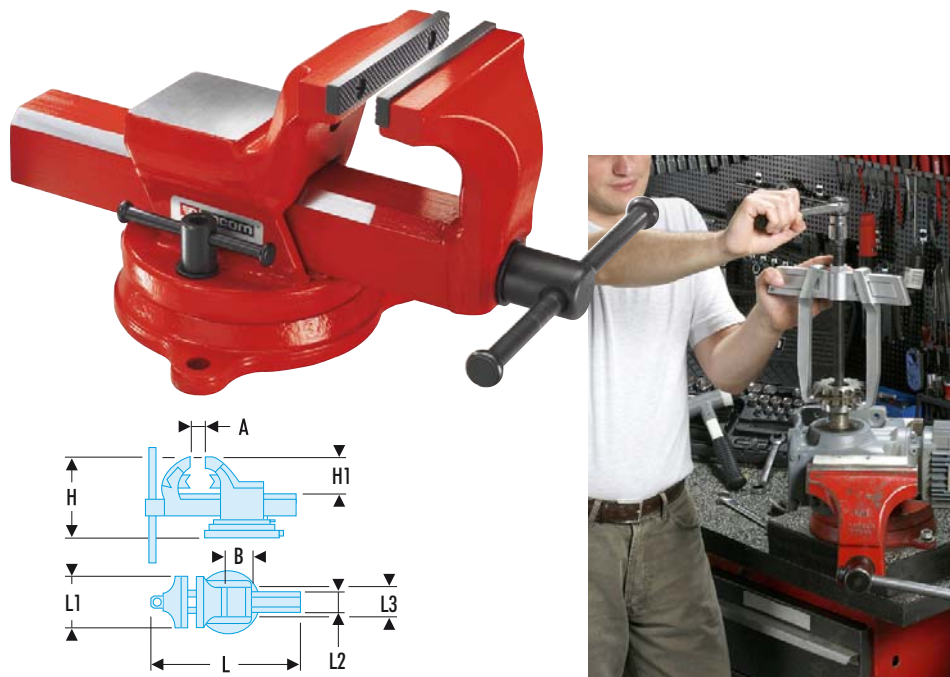

- Interchangeable jaws.
- Gap compensation.
- All steel.

➤	A maxi [mm]	B [mm]	H [mm]	H1 [mm]	L [mm]	L1 [mm]	L2 [mm]	L3 [mm]	ΔΔ [kg]
1223.105	130	57	153	72	300	105	62	45	8,500
1223.125	150	70	180	90	350	125	70	50	12,700
1223.150	210	85	210	107	460	150	85	56	21,500

Flange presses

271A - Compact G-clamp

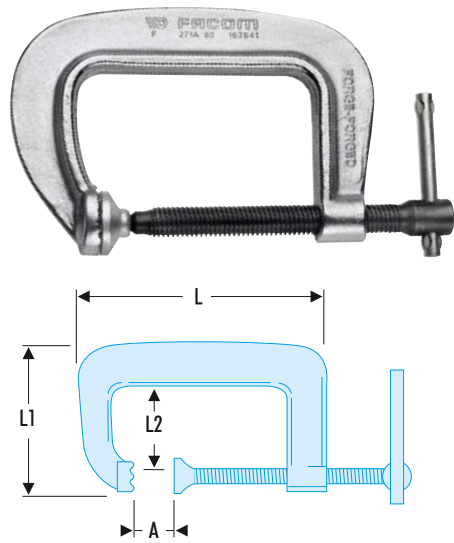

- Capacity: 0 to 250 mm and 0 to 9"7/8.
- Presentation: galvanised - burnished screw.

➤	A maxi [mm]	L [mm]	L1 [mm]	L2 [mm]	ΔΔ [kg]
271A.40	40	100	75	42	0,300
271A.60	60	130	98	57	0,510
271A.80	80	167	115	67	0,810
271A.100	100	192	131	77	1,170
271A.120	120	223	148	88	1,680
271A.150	150	262	162	98	1,980
271A.200	200	320	185	108	3,240
271A.250	250	380	202	118	3,950

271A.L - Deep-throat G-clamp

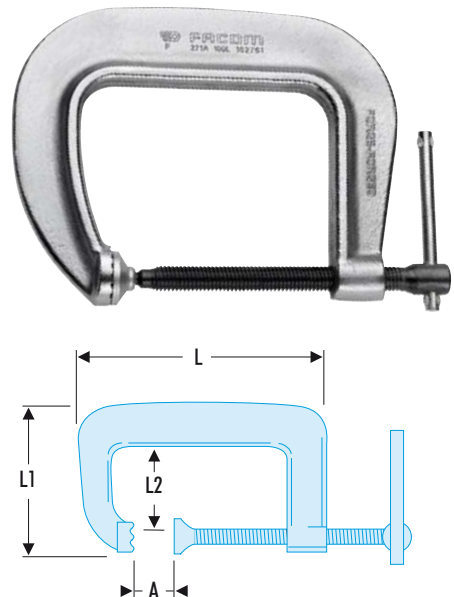

- Capacity: 0 to 150 mm and 0 to 5"7/8.
- Presentation: galvanised - burnished screw.

➤	A maxi [mm]	L [mm]	L1 [mm]	L2 [mm]	ΔΔ [kg]
271A.150L	133	288	213	133	3,320

Arc-welding G-clamp

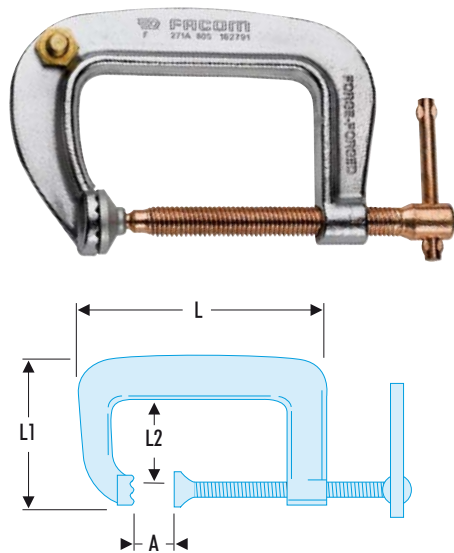

- Capacity: 0 to 80 mm and 0 to 3"1/8.
- Copper-plated screw and brass bolt for earth connection.
- Presentation: galvanised.

➤	A maxi [mm]	L [mm]	L1 [mm]	L2 [mm]	ΔΔ [g]
271A.80S	80	167	115	67	920

